

Laboratory Automation Selection Guide

Issue 2

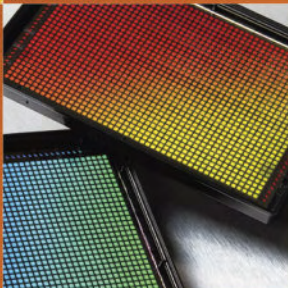
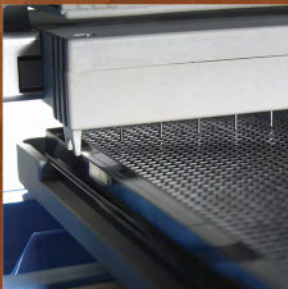
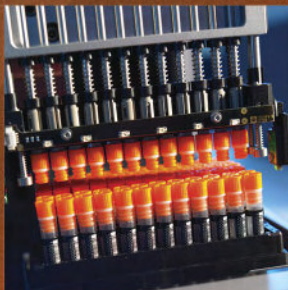
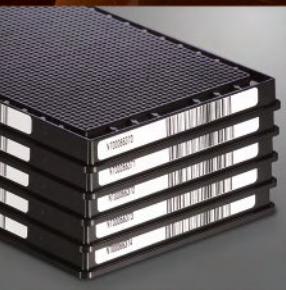

CORNING

AXYGEN

The Equipment Compatibility Program

Quality and Compatibility, Only from Corning.

Corning Life Sciences maintains a comprehensive equipment compatibility program in which leading equipment manufacturers certify the compatibility of our products with their instruments. This information is continually updated with our new products as well as new instruments.

Corning microplates offer compatibility with a wide range of laboratory instrumentation, including microplate readers, microplate washers, liquid handling instruments, automation accessories, and robotic systems. To make it easy to identify the Corning microplates that perform well with your instruments, we've assembled an Equipment Reference Guide with the help of manufacturers from throughout the industry. The Guide is available at www.corning.com/lifesciences. To ensure the accuracy of this reference guide, we invited leading manufacturers to test our microplates on their instruments using extensive criteria for fit and function. For example, a microplate reader manufacturer would have tested a Corning microplate for proper fit in the microplate carrier, suitable optical performance, and compatibility with all of the instrument's accessories, including microplate stackers and bar code readers. If the microplate met all criteria, the manufacturer then signed a form certifying that the microplate was tested for fit and function and found compatible with their instrument and all relevant accessories. So you have their assurance as well as ours that the Corning microplates you choose will perform as needed. Please use this Equipment Reference Guide with confidence.

Expert assistance is just a telephone call or email away

Customer service and technical representatives are available to answer any question – from pricing and product availability to protocols and applications advice. Our offices around the world are able to respond promptly to your inquiry regardless of your location. Please refer to the back cover of this guide for details on your local Corning office. Customers in the U.S. can contact Corning and Axygen by the numbers below.

Corning Technical Service
t 800.492.1110, Option 3
e CLSTechServ@corning.com

Axygen Technical Service
t 800.494.8900
e sales@axigen.com



Ultra Smooth Surfaces

Utilizing a unique manufacturing process, Axygen Scientific has developed an innovative series of pipet tips, filter tips, PCR products and microcentrifuge tubes that feature ultra smooth surfaces.

MAXIMUM RECOVERY®
Tip after dispensing
100 µL sample



Other Leading Tip
after dispensing
100 µL sample



Look for this logo to identify products that meet the Standards ANSI 1-2004 through ANSI 4-2004.



This logo identifies tips packaged in hanging tip racks.

ORDERING INFORMATION 4

AURORA BIOMED
 Versa® 6

BIOTEK®
 Precision™ and Precision XS 8

DYNAMIC DEVICES
 Oasis LM 10

HAMILTON® MICROLAB®
 STAR, STARlet and STARplus 12

PROGROUP WELLPRO
 3000-96 and 3000-384 13

TECAN®
 Genesis Freedom®, Freedom Evo® and Miniprep with LiHa 14
 Freedom Evo, TeMo and Aquarius 16

ZYMARK®/CALIPER
 RapidPlate® and SciClone® 18
 RapidPlate, SciClone and Zephyr® 19

AGILENT/VELOCITY11®
 VPrep® and Bravo 20

BECKMAN COULTER®
 Biomek® FX, Biomek NX and Multimek™ 32
 Biomek FX, Biomek NX, Biomek 3000 and Multimek 33
 Biomek FX and Biomek NX with SPAN-8 liquid level sensing head 34
 Biomek 1000 and Biomek 2000 35
 Multimek and SAGIAN Multipipette 36

PERKINELMER®
 Janus®, Evolution P³, MiniTrak and PlateTrak® 38
 Janus and MultiProbe 39

QIAGEN®
 BioRobot® Series 41

CORNING® EPIC® TECHNOLOGY 46

TECHNICAL APPENDICES
 Corning Assay Surface Properties and Applications 22
 Microplate Compatibility Guide 23
 Equipment Compatibility Chart 31
 Selected Corning Technical Literature 48

FEATURED PRODUCTS

Bar Coded Storage Tubes ...9

Generic Bar Coded
 Microplates11

Microplate Shaker.....22

Single- and Multi-well
 Reservoirs36

Transwell® Permeable
 Supports37

Microplate Lids.....37

Pressure Sensitive Sealing
 Films.....42

PlateMax® Plate Sealer.....42

Reagent Reservoirs.....43

Heal Seal Rolls43

Deep Well Plates.....44

AxyMat and ImpermaMat™
 Sealing Mats45

Please note: Products labeled “sterile” are gamma or e-beam irradiated.
 Sterility cannot be guaranteed if packaging has been compromised.

Ordering Products Direct From Corning

For our U.S. customers who currently have Corning accounts, you can order direct through our Customer Service Group or online:

t 800.492.1110 / 978.442.2200
f 978.442.2476
e CLSCustServ@corning.com
w www.corning.com/lifesciences

Hours of Operation: Monday to Friday, 8am to 6pm (Eastern Standard Time)

Customers outside of the U.S. should contact your local Corning office. Please see back cover for locations or visit www.corning.com/lifesciences and click on “Contact Us”.

Online Orders:

In order to purchase Corning products online, please visit www.corning.com/lifesciences. Click on “Login/Sign Up”, and complete the online registration form. Customers using credit cards may immediately place orders. Full Service Direct accounts with account specific contract pricing will need to establish a direct account with Corning Customer Service before online transactions can be made. You can complete the online registration form or contact Corning Customer Service directly at 1.800.492.1110 in order to establish a direct account with Corning.

Ordering Products through Our Distributors

Customers can purchase Corning products from any one of our more than 50 authorized distributors. See our complete listing online at www.corning.com/lifesciences. Our distribution partners can offer our customers a variety of value-added services from local inventory and service, to managed services and preferred programs. Please contact your distributor of choice for more details.

Product Return Policy

To return product, contact your local Customer Service representative. In some countries, the order number and lot number details are required. Please have this information available to obtain a Return Authorization Number (RNA). This RNA must be referenced on the outside of the shipping carton. Returns without an appropriate RNA will be refused and returned at the customer's expense.



Ordering Products Direct from Axxygen

All technical support and general inquiries should be made with our California facility:

t 800.429.9436 / 510.494.8900
f 510.494.0700
e sales@axygen.com
w www.axxygen.com

Hours of Operation: Monday to Friday, 8am to 5pm (Pacific Standard Time)

Customers outside of the U.S., please contact your local Axxygen distributor. Visit www.axxygen.com and click on "Contact Us".

Minimum Orders

There is a minimum order for all orders placed in the United States and Canada of \$500 (USD). The minimum order for all other countries is \$3000 (USD). Minimum orders for all individual items is one case.

Product Return Policy

Product returns are accepted only by prior authorization. Unauthorized returns will be sent back to sender. Please contact Axxygen Customer Service for forwarding instructions. We do not accept product returns from shipments which were made more than 90 days prior to the request date (120 days for international shipments). A 20% restocking fee may apply to return requests.

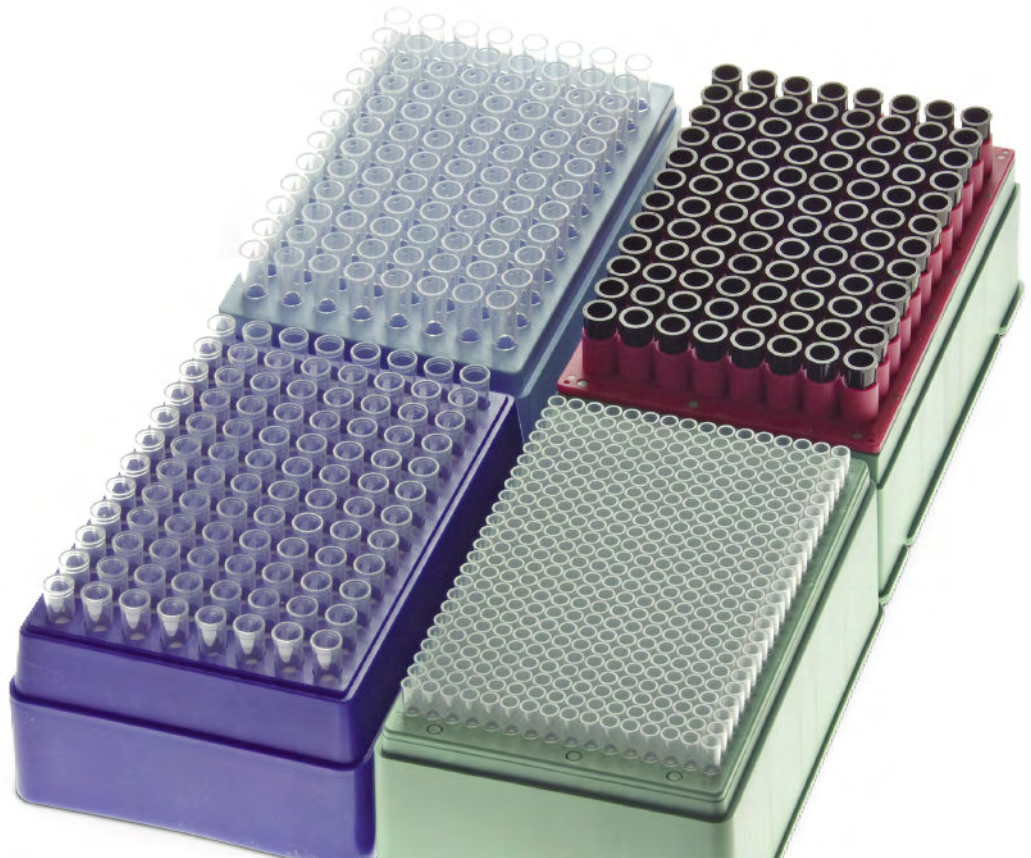





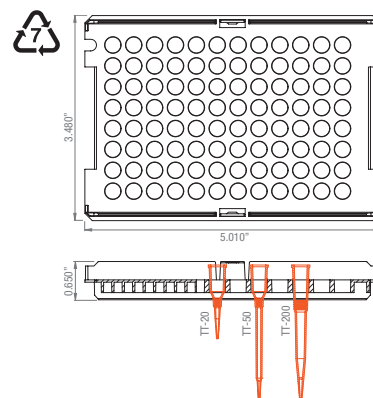





Format: 96 tip
 Tip Volume Range Selection: 10 µL - 1000 µL
 Material: Clear Polypropylene
 Certified RNase-/DNase-free, nonpyrogenic
 Available Options:
 ▶ With or without aerosol-resistant filters
 ▶ Nonsterile or sterilized



Tip Box Format: Non-ANSI hanging tip rack
 Material: Number 7 Polycarbonate

Axygen® Robotic Tips

Type	Max Volume	Compatible Head	Tip Box	Packaging	Standard Cat. No.
Non-Filtered	20 µL	8-Channel		Nonsterile Sterile <i>Quantity: 96 tips/rack, 24 racks/case</i>	TT-20-C-HTR TT-20-C-HTR-S
Filtered	10 µL	8-Channel		Sterile <i>Quantity: 96 tips/rack, 24 racks/case</i>	TTF-20-C-HTR-S
Non-Filtered	50 µL	8-Channel		Nonsterile Sterile <i>Quantity: 96 tips/rack, 24 racks/case</i>	TT-50-C-HTR TT-50-C-HTR-S
Filtered	25 µL	8-Channel		Sterile <i>Quantity: 96 tips/rack, 24 racks/case</i>	TTF-50-C-HTR-S
Non-Filtered	200 µL	8-Channel		Nonsterile Sterile <i>Quantity: 96 tips/rack, 24 racks/case</i>	TT-200-C-HTR TT-200-C-HTR-S
Filtered	175 µL	8-Channel		Sterile <i>Quantity: 96 tips/rack, 24 racks/case</i>	TTF-200-C-HTR-S
Non-Filtered	1000 µL	8-Channel		Nonsterile Sterile <i>Quantity: 96 tips/rack, 16 racks/case</i>	TT-1000-C-HTR TT-1000-C-HTR-S
Filtered	1000 µL	8-Channel		Sterile <i>Quantity: 96 tips/rack, 16 racks/case</i>	TTF-1000-C-HTR-S

Format: 96 tip
 Tip Volume Range Selection: 10 µL - 1000 µL
 Material: Conductive LLS Black Polypropylene
 Certified RNase-/DNase-free, nonpyrogenic
 Available Options:
 ▶ With or without aerosol-resistant filters
 ▶ Nonsterile or sterilized

Tip Box Format: Non-ANSI hanging tip rack
 Material: Number 7 Polycarbonate

Axygen® Robotic Tips

Type	Max Volume	Compatible Head	Tip Box	Packaging	Standard Cat. No.
 Conductive, Non-Filtered	20 µL	8-Channel	 <small>HANGING TIP RACKS</small>	Nonsterile Sterile <i>Quantity: 96 tips/rack, 24 racks/case</i>	TT-20-CBK-HTR TT-20-CBK-HTR-S
 Conductive, Filtered	10 µL	8-Channel	 <small>HANGING TIP RACKS</small>	Sterile <i>Quantity: 96 tips/rack, 24 racks/case</i>	TTF-20-CBK-HTR-S
 Conductive, Non-Filtered	50 µL	8-Channel	 <small>HANGING TIP RACKS</small>	Nonsterile Sterile <i>Quantity: 96 tips/rack, 24 racks/case</i>	TT-50-CBK-HTR TT-50-CBK-HTR-S
 Conductive, Filtered	25 µL	8-Channel	 <small>HANGING TIP RACKS</small>	Sterile <i>Quantity: 96 tips/rack, 24 racks/case</i>	TTF-50-CBK-HTR-S
 Conductive, Non-Filtered	200 µL	8-Channel	 <small>HANGING TIP RACKS</small>	Nonsterile Sterile <i>Quantity: 96 tips/rack, 24 racks/case</i>	TT-200-CBK-HTR TT-200-CBK-HTR-S
 Conductive, Filtered	175 µL	8-Channel	 <small>HANGING TIP RACKS</small>	Sterile <i>Quantity: 96 tips/rack, 24 racks/case</i>	TTF-200-CBK-HTR-S
 Conductive, Non-Filtered	1000 µL	8-Channel	 <small>HANGING TIP RACKS</small>	Nonsterile Sterile <i>Quantity: 96 tips/rack, 16 racks/case</i>	TT-1000-CBK-HTR TT-1000-CBK-HTR-S
 Conductive, Filtered	1000 µL	8-Channel	 <small>HANGING TIP RACKS</small>	Sterile <i>Quantity: 96 tips/rack, 16 racks/case</i>	TTF-1000-CBK-HTR-S

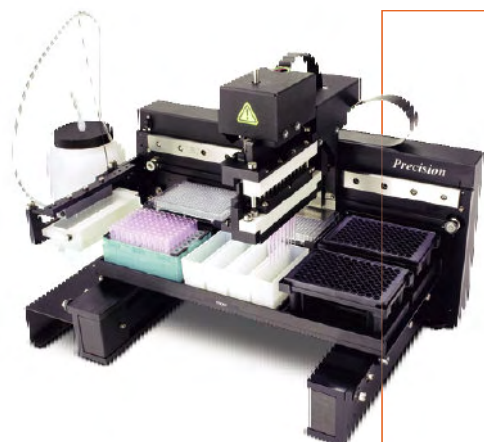

Format: 96 tip
 Tip Volume Range Selection: 50 µL - 200 µL
 Material: Clear Polypropylene
 Certified RNase-/DNase-free, nonpyrogenic
 Available Options:
 ▶ With or without aerosol-resistant filters
 ▶ Nonsterile or sterilized

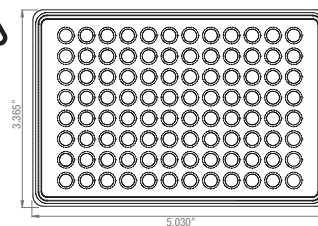

Tip Box Format: ANSI
 Material: Number 5 Polypropylene

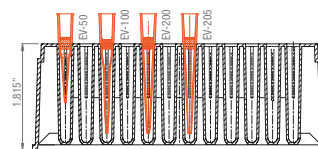

Axygen® Robotic Tips

Type	Max Volume	Compatible Head	Tip Box	Packaging	Standard Cat. No.
Non-Filtered	50 µL	8 or 12		Nonsterile Sterile <i>Quantity: 96 tips/rack, 10 racks/pack, 5 packs/case</i>	EV-50-R EV-50-R-S
Filtered	50 µL	8 or 12		Sterile <i>Quantity: 96 tips/rack, 10 racks/pack, 5 packs/case</i>	EVF-50-R-S
Non-Filtered	100 µL	8 or 12		Nonsterile Sterile <i>Quantity: 96 tips/rack, 10 racks/pack, 5 packs/case</i>	EV-100-R EV-100-R-S
Filtered	80 µL	8 or 12		Sterile <i>Quantity: 96 tips/rack, 10 racks/pack, 5 packs/case</i>	EVF-100-R-S
Non-Filtered	200 µL	8 or 12		Nonsterile Sterile <i>Quantity: 96 tips/rack, 10 racks/pack, 5 packs/case</i>	EV-200-R EV-200-R-S
Filtered	180 µL	8 or 12		Sterile <i>Quantity: 96 tips/rack, 10 racks/pack, 5 packs/case</i>	EVF-180-R-S
Wide-Bore, Non-Filtered	200 µL	8 or 12		Nonsterile Sterile <i>Quantity: 96 tips/rack, 10 racks/pack, 5 packs/case</i>	EV-205-WB-R EV-205-WB-R-S
Wide-Bore, Filtered	180 µL	8 or 12		Sterile <i>Quantity: 96 tips/rack, 10 racks/pack, 5 packs/case</i>	EVF-205-WB-R-S

Corning® 96 1D/2D Bar Coded Storage Tubes

Compared to the competition, the 1D/2D storage line is a superior storage solution designed to provide maximum identification.

- ▶ Maximum Identification – Synchronized 2D and linear bar code, along with marking spot
- ▶ Maximum Information – 14 x 14 dot 2D bar code
- ▶ Bar code stability – Laser-etched, not an attached label
- ▶ Compound compatibility – Polypropylene construction throughout, making it very inert

96 1D/2D Bar Coded Storage Tubes (Cat. No. 8502)

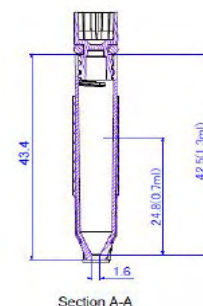

Cat. No.	Product Description	Qty/Pk	Pk/Cs	Qty/Cs
8500	96 1D/2D Bar Coded Storage Tubes, 1.3 mL, without screw caps, bulk pack	96/pk	10 pk/cs	960 tubes/cs
8501	96 1D/2D Bar Coded Storage Tubes, 1.3 mL, without screw caps, racked with cover	96/rack	10 racks/cs	960 tubes/cs
8502	96 1D/2D Bar Coded Storage Tubes, 1.3 mL, with screw caps, bulk pack	96/pk	10 pk/cs	960 tubes/cs
8503	96 1D/2D Bar Coded Storage Tubes, 1.3 mL, with screw caps, racked with cover	96/rack	10 racks/cs	960 tubes/cs
8504	96 Storage Tube Screw Cap, polypropylene with O-Ring, bulk pack	96/pk	50 pk/cs	4800 caps/cs
8505	96 Storage Tube Screw Cap, polypropylene with O-Ring, on mat, 96 caps per mat, clear with cover	480/pk	10 pk/cs	4800 caps/cs
8506	Thermoplastic elastomer (TPE) 96 Storage Tube Septum Cap, bulk pack	96/pk	100 pk/cs	9600 caps/cs
8507	Thermoplastic elastomer (TPE) 96 Storage Tube Septum Cap on mat, 96 caps per mat	960/pk	5 pk/cs	4800 caps/cs
8508	Empty racks with lids for 96 Screw Capped or Thermoplastic Elastomers (TPE) Capped Storage Tubes	5 racks/pk	2 pk/cs	10 racks/cs
8509	384 2D Bar Coded Storage Tubes, round, without plug caps, racked	384/pk	20 pk/cs	7680 tubes/cs
8510	384 2D Bar Coded Storage Tubes, square, racked	384/pk	20 pk/cs	7680 tubes/cs
8511	384 Storage Tube Plug Cap for round tube, bulk pack	384/pk	100 pk/cs	38400 caps/cs
8512	384 Storage Tube Plug Cap on mats for round tube, 384 caps per mat	3840/pk	10 pk/cs	38400 caps/cs
8513	Empty racks with lids for 384 round or square Storage Tubes	1 rack/pk	20 pk/cs	20 racks/cs

384 Square Tube (Cat. No. 8510)

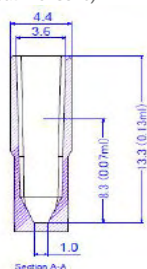

384 Round Tube (Cat. No. 8509)

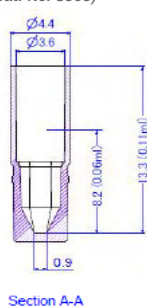

384 2D Bar Coded Storage Tubes (Cat. No. 8509)

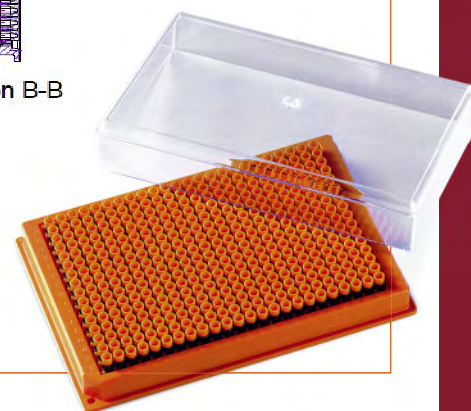
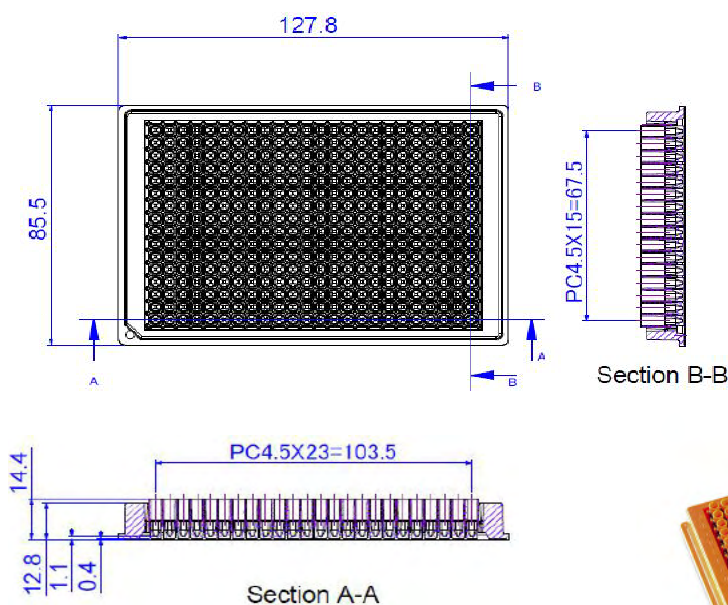



Format: 96 tip
 Tip Volume Range Selection: 50 µL - 200 µL
 Material: Clear Polypropylene
 Certified RNase-/DNase-free, nonpyrogenic
 Available Options:
 ▶ With or without aerosol-resistant filters
 ▶ Nonsterile or sterilized

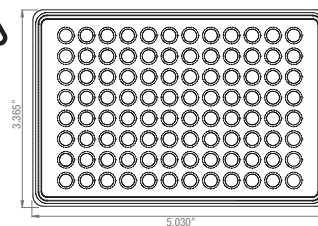

Tip Box Format: ANSI
 Material: Number 5 Polypropylene

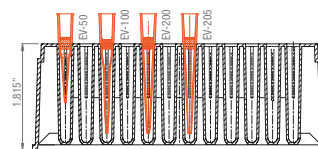

Axygen® Robotic Tips

Type	Max Volume	Compatible Head	Tip Box	Packaging	Standard Cat. No.
Non-Filtered	50 µL	8/96-Channel-Standard Vol, 96-Ch.-Low Vol	 	Nonsterile Sterile <i>Quantity: 96 tips/rack, 10 racks/pack, 5 packs/case</i>	EV-50-R EV-50-R-S
Filtered	50 µL	8/96-Channel-Standard Vol, 96-Ch.-Low Vol	 	Sterile <i>Quantity: 96 tips/rack, 10 racks/pack, 5 packs/case</i>	EVF-50-R-S
Non-Filtered	100 µL	8/96-Channel-Standard Vol	 	Nonsterile Sterile <i>Quantity: 96 tips/rack, 10 racks/pack, 5 packs/case</i>	EV-100-R EV-100-R-S
Filtered	80 µL	8/96-Channel-Standard Vol	 	Sterile <i>Quantity: 96 tips/rack, 10 racks/pack, 5 packs/case</i>	EVF-100-R-S
Non-Filtered	200 µL	8/96-Channel-Standard Vol	 	Nonsterile Sterile <i>Quantity: 96 tips/rack, 10 racks/pack, 5 packs/case</i>	EV-200-R EV-200-R-S
Filtered	180 µL	8/96-Channel-Standard Vol	 	Sterile <i>Quantity: 96 tips/rack, 10 racks/pack, 5 packs/case</i>	EVF-180-R-S
Non-Filtered	200 µL	8/96-Channel-Standard Vol	 	Nonsterile Sterile <i>Quantity: 96 tips/rack, 10 racks/pack, 5 packs/case</i>	EV-205-WB-R EV-205-WB-R-S
Filtered	180 µL	8/96-Channel-Standard Vol	 	Sterile <i>Quantity: 96 tips/rack, 10 racks/pack, 5 packs/case</i>	EVF-205-WB-R-S

Format: 384 tip
 Tip Volume Range Selection: 25 µL - 50 µL
 Material: Clear Polypropylene
 Certified RNase-/DNase-free, nonpyrogenic
 Available Options:

- ▶ With or without aerosol-resistant filters
- ▶ Nonsterile or sterilized
- ▶ Standard or MAXIMUM RECOVERY®

Tip Box Format: ANSI
 Material: Number 5 Polypropylene

Axygen® Robotic Tips

Type	Max Volume	Compatible Head	Tip Box	Packaging	Standard Cat. No.	MAXIMUM RECOVERY Cat. No.
Non-Filtered	50 µL	384-Channel-Low Volume		Nonsterile Sterile <i>Quantity: 384 tips/rack, 10 racks/pack, 5 packs/case</i>	FX-384-XL-R FX-384-XL-R-S	FX-384-XL-L-R FX-384-XL-L-R-S
Filtered	30 µL	384-Channel-Low Volume		Sterile <i>Quantity: 384 tips/rack, 10 racks/pack, 5 packs/case</i>	FXF-384-XL-R-S	FXF-384-XL-L-R-S
Non-Filtered	30 µL	384-Channel-Low Volume		Nonsterile Sterile <i>Quantity: 384 tips/rack, 10 racks/pack, 5 packs/case</i>	FX-384-R FX-384-R-S	FX-384-L-R FX-384-L-R-S
Filtered	25 µL	384-Channel-Low Volume		Sterile <i>Quantity: 384 tips/rack, 10 racks/pack, 5 packs/case</i>	FXF-384-R-S	FXF-384-L-R-S



Corning Generic Bar Coded Microplates

Cat. No.	Description	Qty/Cs	Cat. No.	Description	Qty/Cs
384 Well Microplates			1536 Well Microplates		
3574BC	White, solid, NBS™	50	3724BC	Black, solid, not treated	50
3575BC	Black, solid, NBS	50	3725BC	White, solid, not treated	50
3640BC	Clear, NBS	100	3727BC	White, solid, TC-treated, sterile with lid	50
3683BC	Black, clear bottom, Corning® CellBIND® Surface, sterile with lid	50	3728BC	Black, solid, NBS	50
3702BC	Clear, not treated	100	3729BC	White, solid, NBS	50
3821BC	Black, low volume, solid, not treated	50	3832BC	Black, clear bottom, low base, Corning CellBIND Surface, sterile with lid	50
3824BC	White, low volume, solid, NBS	50	3838BC	Black, clear bottom, low base, TC-treated, sterile with lid	50
3826BC	White, low volume, solid, TC-treated, sterile with lid	50	3891BC	Black, clear bottom, not treated	50
			3893BC	Black, clear bottom, TC-treated, sterile with lid	50
			3895BC	Black, clear bottom, NBS	50



Format: 384 tip
 Tip Volume Range Selection: 25 µL - 50 µL
 Material: Clear Polypropylene
 Certified RNase-/DNase-free, nonpyrogenic
 Available Options:
 ▶ With or without aerosol-resistant filters
 ▶ Nonsterile or sterilized
 ▶ Standard or MAXIMUM RECOVERY®

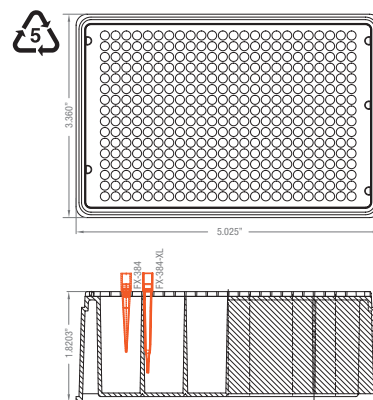

Tip Box Format: ANSI
 Material: Number 5 Polypropylene

Axygen® Robotic Tips

Type	Max Volume	Compatible Head	Tip Box	Packaging	Standard Cat. No.	MAXIMUM RECOVERY® Cat. No.
Non-Filtered	50 µL	384		Nonsterile Sterile Quantity: 384 tips/rack, 10 racks/pack, 5 packs/case	FX-384-XL-R FX-384-XL-R-S	FX-384-XL-L-R FX-384-XL-L-R-S
Filtered	30 µL	384		Sterile Quantity: 384 tips/rack, 10 racks/pack, 5 packs/case	FXF-384-XL-R-S	FXF-384-XL-L-R-S
Non-Filtered	30 µL	384		Nonsterile Sterile Quantity: 384 tips/rack, 10 racks/pack, 5 packs/case	FX-384-R FX-384-R-S	FX-384-L-R FX-384-L-R-S
Filtered	25 µL	384		Sterile Quantity: 384 tips/rack, 10 racks/pack, 5 packs/case	FXF-384-R-S	FXF-384-L-R-S

Benefits of the Corning® Nonbinding Surface Chemistry (NBS™) Microplates on Homogeneous Assays

Fluorescence-based Assay Performance with Corning NBS Chemistry Low Volume Microplates

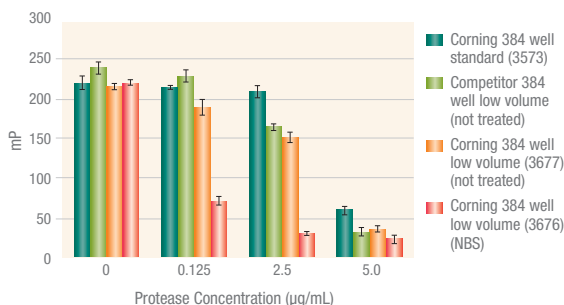

Higher Sensitivity for Fluorescence Polarization Assays with 384 Well Corning NBS Chemistry Low Volume Microplates (Cat. No. 3676)

Data demonstrates *Streptomyces griseus* protease activity on BODIPY fluorescent labeled (FL) casein substrate. Protease activity is measured as a reduction in millipolarization (mP) units. A significant reduction in fluorescence polarization was observed at the lowest concentration of enzyme in a 10 µL volume.

Reduced Nonspecific Protein Binding with Corning NBS Chemistry Microplates



NBS Chemistry Significantly Reduces Nonspecific Binding of a BODIPY FL Casein Substrate to Corning Microplates

Dilutions of BODIPY FL casein in digestion buffer were incubated for 30 minutes at room temperature in black Corning untreated and NBS Chemistry microplates (Cat. No. 3655). Control wells contained digestion buffer only. Microplates were washed 3 times with PBS, pH 7.4, and 200 µL/well of digestion buffer alone was added to the wells. Fluorescence intensity was measured.



www.serialdilution.com

Format: 96 tip and 384 tip
 Tip Volume Range Selection: 30 µL - 200 µL
 Material: Clear Polypropylene
 Certified RNase-/DNase-free, nonpyrogenic
 Available Options:
 ▶ With or without aerosol-resistant filters
 ▶ Nonsterile or sterilized
 ▶ Standard or MAXIMUM RECOVERY®

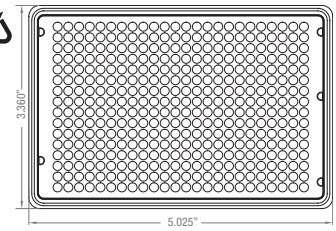

Tip Box Format: Non-ANSI (96) and ANSI (384)
 Material: Number 5 Polypropylene

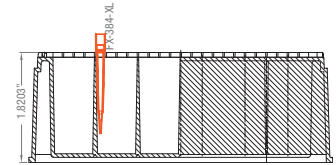

Axygen® Robotic Tips

Type	Max Volume	Compatible Head	Tip Box	Packaging	Standard Cat. No.	MAXIMUM RECOVERY Cat. No.
Non-Filtered	50 µL	16/24-Channel	 ANSI	Nonsterile Sterile Quantity: 384 tips/rack, 10 racks/pack, 5 packs/case	FX-384-XL-R FX-384-XL-R-S	FX-384-XL-L-R FX-384-XL-L-R-S
Filtered	30 µL	16/24-Channel	 ANSI	Sterile Quantity: 384 tips/rack, 10 racks/pack, 5 packs/case	FXF-384-XL-R-S	FXF-384-XL-L-R-S
Non-Filtered	200 µL	8/12-Channel		Nonsterile Sterile Quantity: 96 tips/rack, 10 racks/pack, 5 packs/case	TWP-200-R TWP-200-R-S	
Filtered	120 µL	8/12-Channel		Sterile Quantity: 96 tips/rack, 10 racks/pack, 5 packs/case	TWPF-120-R-S	

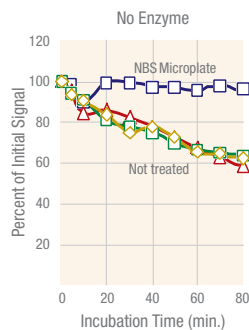
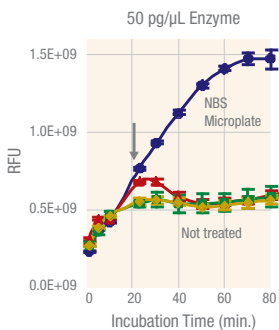

The Nonbinding Surface Chemistry (NBS™) Can Be Essential for Assay Performance

Kinases represent major screening assay targets, and yet due to the hydrophobicity of these proteins and their substrates, not treated polystyrene can be problematic to assay development. Not treated 384 well black solid bottom microplates were compared to NBS Chemistry microplates using a kinase assay from ABI.

The graph on the left shows that loss of substrate in solution occurs within 20 minutes on a not treated microplate, but is sustained for at least 60 minutes using NBS microplates. The graph on the right demonstrates that, in the absence of enzyme, the background from the fluorescent substrate is quickly adsorbed by the microplate walls of a not treated microplate, but not on NBS walls.

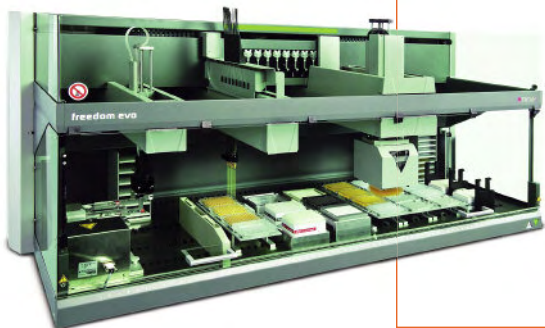





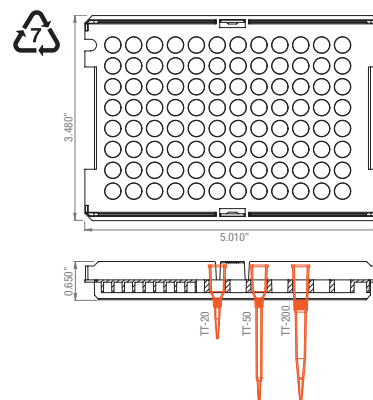



Format: 96 tip
 Tip Volume Range Selection: 10 µL - 1000 µL
 Material: Clear Polypropylene
 Certified RNase-/DNase-free, nonpyrogenic
 Available Options:

- ▶ With or without aerosol-resistant filters
- ▶ Nonsterile or sterilized



Tip Box Format: Non-ANSI hanging tip rack
 Material: Number 7 Polycarbonate

Axygen® Robotic Tips

Type	Max Volume	Compatible Head	Tip Box	Packaging	Standard Cat. No.
Non-Filtered	20 µL	LiHa -1, -4, -8		Nonsterile Sterile <i>Quantity: 96 tips/rack, 24 racks/case</i>	TT-20-C-HTR TT-20-C-HTR-S
Filtered	10 µL	LiHa -1, -4, -8		Sterile <i>Quantity: 96 tips/rack, 24 racks/case</i>	TTF-20-C-HTR-S
Non-Filtered	50 µL	LiHa -1, -4, -8		Nonsterile Sterile <i>Quantity: 96 tips/rack, 24 racks/case</i>	TT-50-C-HTR TT-50-C-HTR-S
Filtered	25 µL	LiHa -1, -4, -8		Sterile <i>Quantity: 96 tips/rack, 24 racks/case</i>	TTF-50-C-HTR-S
Non-Filtered	200 µL	LiHa -1, -4, -8		Nonsterile Sterile <i>Quantity: 96 tips/rack, 24 racks/case</i>	TT-200-C-HTR TT-200-C-HTR-S
Filtered	175 µL	LiHa -1, -4, -8		Sterile <i>Quantity: 96 tips/rack, 24 racks/case</i>	TTF-200-C-HTR-S
Non-Filtered	1000 µL	LiHa -1, -4, -8		Nonsterile Sterile <i>Quantity: 96 tips/rack, 16 racks/case</i>	TT-1000-C-HTR TT-1000-C-HTR-S
Filtered	1000 µL	LiHa -1, -4, -8		Sterile <i>Quantity: 96 tips/rack, 16 racks/case</i>	TTF-1000-C-HTR-S

Format: 96 tip
 Tip Volume Range Selection: 10 µL - 1000 µL
 Material: Conductive Black Polypropylene
 Certified RNase-/DNase-free, nonpyrogenic
 Available Options:
 ▶ With or without aerosol-resistant filters
 ▶ Nonsterile or sterilized

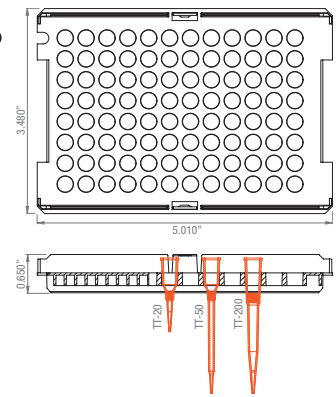

Tip Box Format: Non-ANSI hanging tip rack
 Material: Number 7 Polycarbonate

Axygen® Robotic Tips

Type	Max Volume	Compatible Head	Tip Box	Packaging	Standard Cat. No.
Conductive, Non-Filtered	20 µL	LiHa -1, -4, -8		Nonsterile	TT-20-CBK-HTR
				Sterile	TT-20-CBK-HTR-S
<i>Quantity: 96 tips/rack, 24 racks/case</i>					
Conductive, Filtered	10 µL	LiHa -1, -4, -8		Sterile	TTF-20-CBK-HTR-S
<i>Quantity: 96 tips/rack, 24 racks/case</i>					
Conductive, Non-Filtered	50 µL	LiHa -1, -4, -8		Nonsterile	TT-50-CBK-HTR
				Sterile	TT-50-CBK-HTR-S
<i>Quantity: 96 tips/rack, 24 racks/case</i>					
Conductive, Filtered	25 µL	LiHa -1, -4, -8		Sterile	TTF-50-CBK-HTR-S
<i>Quantity: 96 tips/rack, 24 racks/case</i>					
Conductive, Non-Filtered	200 µL	LiHa -1, -4, -8		Nonsterile	TT-200-CBK-HTR
				Sterile	TT-200-CBK-HTR-S
<i>Quantity: 96 tips/rack, 24 racks/case</i>					
Conductive, Filtered	175 µL	LiHa -1, -4, -8		Sterile	TTF-200-CBK-HTR-S
<i>Quantity: 96 tips/rack, 24 racks/case</i>					
Conductive, Non-Filtered	1000 µL	LiHa -1, -4, -8		Nonsterile	TT-1000-CBK-HTR
				Sterile	TT-1000-CBK-HTR-S
<i>Quantity: 96 tips/rack, 16 racks/case</i>					
Conductive, Filtered	1000 µL	LiHa -1, -4, -8		Sterile	TTF-1000-CBK-HTR-S
<i>Quantity: 96 tips/rack, 16 racks/case</i>					

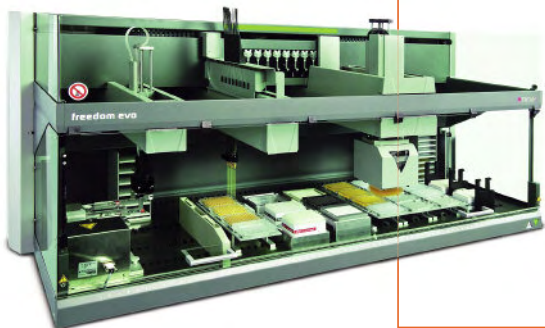

Format: 96 tip
 Tip Volume Range Selection: 50 µL - 200 µL
 Material: Clear Polypropylene
 Certified RNase-/DNase-free, nonpyrogenic
 Available Options:

- ▶ With or without aerosol-resistant filters
- ▶ Nonsterile or sterilized

Tip Box Format: ANSI
 Material: Number 5 Polypropylene

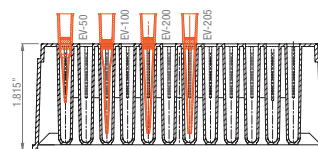
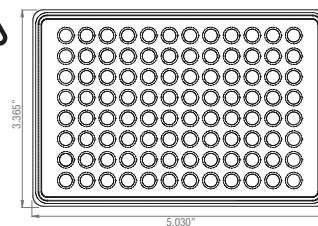

Axygen® Robotic Tips

Type	Max Volume	Compatible Head	Tip Box	Packaging	Standard Cat. No.
Non-Filtered	50 µL	MCA96		Nonsterile Sterile <i>Quantity: 96 tips/rack, 10 racks/pack, 5 packs/case</i>	EV-50-R EV-50-R-S
Filtered	50 µL	MCA96		Sterile <i>Quantity: 96 tips/rack, 10 racks/pack, 5 packs/case</i>	EVF-50-R-S
Non-Filtered	100 µL	MCA96		Nonsterile Sterile <i>Quantity: 96 tips/rack, 10 racks/pack, 5 packs/case</i>	EV-100-R EV-100-R-S
Filtered	80 µL	MCA96		Sterile <i>Quantity: 96 tips/rack, 10 racks/pack, 5 packs/case</i>	EVF-100-R-S
Non-Filtered	200 µL	MCA96		Nonsterile Sterile <i>Quantity: 96 tips/rack, 10 racks/pack, 5 packs/case</i>	EV-200-R EV-200-R-S
Filtered	180 µL	MCA96		Sterile <i>Quantity: 96 tips/rack, 10 racks/pack, 5 packs/case</i>	EVF-180-R-S
Wide-Bore, Non-Filtered	200 µL	MCA96		Nonsterile Sterile <i>Quantity: 96 tips/rack, 10 racks/pack, 5 packs/case</i>	EV-205-WB-R EV-205-WB-R-S
Wide-Bore, Filtered	180 µL	MCA96		Sterile <i>Quantity: 96 tips/rack, 10 racks/pack, 5 packs/case</i>	EVF-205-WB-R-S

Format: 96 tip
 Tip Volume Range Selection: 50 µL - 200 µL
 Material: Clear Polypropylene
 Certified RNase-/DNase-free, nonpyrogenic
 Available Options:

- ▶ With or without aerosol-resistant filters
- ▶ Nonsterile or sterilized
- ▶ Standard or MAXIMUM RECOVERY®

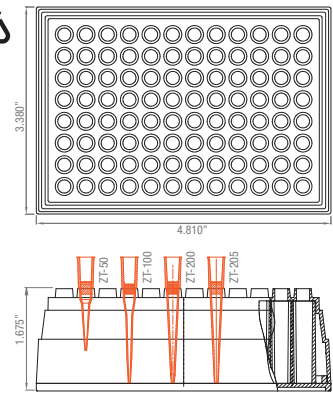

Tip Box Format: Non-ANSI
 Material: Number 5 Polypropylene

Axygen® Robotic Tips

Type	Max Volume	Compatible Head	Tip Box	Packaging	Standard Cat. No.	MAXIMUM RECOVERY Cat. No.
Non-Filtered	50 µL	MCA96, TEM096		Nonsterile Sterile <i>Quantity: 96 tips/rack, 10 racks/pack, 5 packs/case</i>	ZT-50-R ZT-50-R-S	ZT-50-L-R ZT-50-L-R-S
Filtered	50 µL	MCA96, TEM096		Sterile <i>Quantity: 96 tips/rack, 10 racks/pack, 5 packs/case</i>	ZTF-50-R-S	ZTF-50-L-R-S
Non-Filtered	100 µL	MCA96, TEM096		Nonsterile Sterile <i>Quantity: 96 tips/rack, 10 racks/pack, 5 packs/case</i>	ZT-100-R ZT-100-R-S	ZT-100-L-R ZT-100-L-R-S
Filtered	80 µL	MCA96, TEM096		Sterile <i>Quantity: 96 tips/rack, 10 racks/pack, 5 packs/case</i>	ZTF-100-R-S	ZTF-100-L-R-S
Non-Filtered	200 µL	MCA96, TEM096		Nonsterile Sterile <i>Quantity: 96 tips/rack, 10 racks/pack, 5 packs/case</i>	ZT-200-R ZT-200-R-S	ZT-200-L-R ZT-200-L-R-S
Filtered	180 µL	MCA96, TEM096		Sterile <i>Quantity: 96 tips/rack, 10 racks/pack, 5 packs/case</i>	ZTF-200-R-S	ZTF-200-L-R-S
Wide-Bore, Non-Filtered	200 µL	MCA96, TEM096		Nonsterile Sterile <i>Quantity: 96 tips/rack, 10 racks/pack, 5 packs/case</i>	ZT-205-WB-R ZT-205-WB-R-S	ZT-205-WB-L-R ZT-205-WB-L-R-S
Wide-Bore, Filtered	180 µL	MCA96, TEM096		Sterile <i>Quantity: 96 tips/rack, 10 racks/pack, 5 packs/case</i>	ZTF-205-WB-R-S	ZTF-205-WB-L-R-S



Format: 96 tip
 Tip Volume Range Selection: 25 µL - 200 µL
 Material: Clear Polypropylene
 Certified RNase-/DNase-free, nonpyrogenic
 Available Options:

- ▶ With or without aerosol-resistant filters
- ▶ Nonsterile or sterilized
- ▶ Standard or MAXIMUM RECOVERY®

Tip Box Format: Non-ANSI (96) and ANSI (384)
 Material: Number 5 Polypropylene

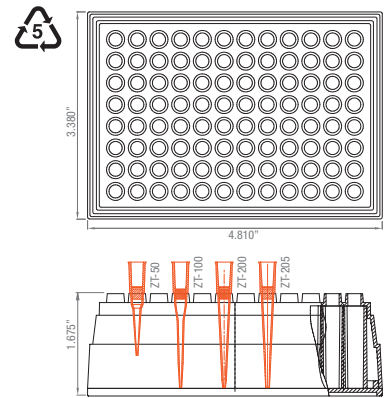

Axygen® Robotic Tips

Type	Max Volume	Compatible Head	Tip Box	Packaging	Standard Cat. No.	MAXIMUM RECOVERY Cat. No.
Non-Filtered	50 µL	HV96		Nonsterile Sterile <i>Quantity: 96 tips/rack, 10 racks/pack, 5 packs/case</i>	ZT-50-R ZT-50-R-S	ZT-50-L-R ZT-50-L-R-S
Filtered	50 µL	HV96		Sterile <i>Quantity: 96 tips/rack, 10 racks/pack, 5 packs/case</i>	ZTF-50-R-S	ZTF-50-L-R-S
Non-Filtered	100 µL	HV96 CAS-4200-1ch.- 20-150 µL/sec.		Nonsterile Sterile <i>Quantity: 96 tips/rack, 10 racks/pack, 5 packs/case</i>	ZT-100-R ZT-100-R-S	ZT-100-L-R ZT-100-L-R-S
Filtered	80 µL	HV96 CAS-4200-1ch.- 20-150 µL/sec.		Sterile <i>Quantity: 96 tips/rack, 10 racks/pack, 5 packs/case</i>	ZTF-100-R-S	ZTF-100-L-R-S
Non-Filtered	200 µL	HV96 CAS-4200-1ch.- 20-150 µL/sec.		Nonsterile Sterile <i>Quantity: 96 tips/rack, 10 racks/pack, 5 packs/case</i>	ZT-200-R ZT-200-R-S	ZT-200-L-R ZT-200-L-R-S
Filtered	180 µL	HV96 CAS-4200-1ch.- 20-150 µL/sec.		Sterile <i>Quantity: 96 tips/rack, 10 racks/pack, 5 packs/case</i>	ZTF-200-R-S	ZTF-200-L-R-S
Wide-Bore, Non-Filtered	200 µL	HV96 CAS-4200-1ch.- 20-150 µL/sec.		Nonsterile Sterile <i>Quantity: 96 tips/rack, 10 racks/pack, 5 packs/case</i>	ZT-205-WB-R ZT-205-WB-R-S	ZT-205-WB-L-R ZT-205-WB-L-R-S
Wide-Bore, Filtered	180 µL	HV96 CAS-4200-1ch.- 20-150 µL/sec.		Sterile <i>Quantity: 96 tips/rack, 10 racks/pack, 5 packs/case</i>	ZTF-205-WB-R-S	ZTF-205-WB-L-R-S
Non-Filtered	25 µL	LV96, LV384		Nonsterile Sterile <i>Quantity: 384 tips/rack, 10 racks/pack, 5 packs/case</i>	ZT-384-C-R ZT-384-C-R-S	

Format: 96 tip
 Tip Volume Range Selection: 25 µL - 200 µL
 Material: Clear Polypropylene
 Certified RNase-/DNase-free, nonpyrogenic
 Available Options:
 ▶ With or without aerosol-resistant filters
 ▶ Nonsterile or sterilized

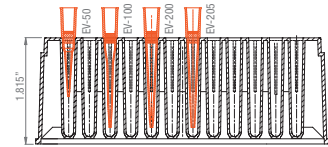
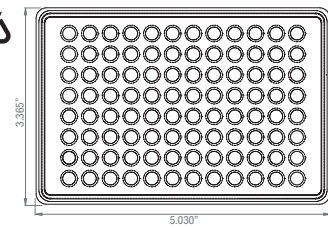

Tip Box Format: ANSI
 Material: Number 5 Polypropylene

Axygen® Robotic Tips

Type	Max Volume	Compatible Head	Tip Box	Packaging	Standard Cat. No.
	50 µL	HV96	 	Nonsterile Sterile Quantity: 96 tips/rack, 10 racks/pack, 5 packs/case	EV-50-R EV-50-R-S
	50 µL	HV96	 	Sterile Quantity: 96 tips/rack, 10 racks/pack, 5 packs/case	EVF-50-R-S
	100 µL	HV96	 	Nonsterile Sterile Quantity: 96 tips/rack, 10 racks/pack, 5 packs/case	EV-100-R EV-100-R-S
	80 µL	HV96	 	Sterile Quantity: 96 tips/rack, 10 racks/pack, 5 packs/case	EVF-100-R-S
	200 µL	HV96	 	Nonsterile Sterile Quantity: 96 tips/rack, 10 racks/pack, 5 packs/case	EV-200-R EV-200-R-S
	180 µL	HV96	 	Sterile Quantity: 96 tips/rack, 10 racks/pack, 5 packs/case	EVF-180-R-S
	200 µL	HV96	 	Nonsterile Sterile Quantity: 96 tips/rack, 10 racks/pack, 5 packs/case	EV-205-WB-R EV-205-WB-R-S
	180 µL	HV96	 	Sterile Quantity: 96 tips/rack, 10 racks/pack, 5 packs/case	EVF-205-WB-R-S
	25 µL	LV96, LV384	 	Nonsterile Sterile Quantity: 384 tips/rack, 10 racks/pack, 5 packs/case	ZT-384-C-R ZT-384-C-R-S

Format: 96 tip
 Tip Volume Range Selection: 20 µL - 250 µL
 Material: Clear Polypropylene
 Certified RNase-/DNase-free, nonpyrogenic
 Available Options:

- ▶ With or without aerosol-resistant filters
- ▶ Nonsterile or sterilized
- ▶ Standard or MAXIMUM RECOVERY®

Tip Box Format: ANSI
 Material: Number 5 Polypropylene

Axygen® Robotic Tips

Type	Max Volume	Compatible Head	Tip Box	Packaging	Standard Cat. No.	MAXIMUM RECOVERY® Cat. No.
Non-Filtered 	60 µL	96LT & 8LT 96LT & 8LT 96LT & 8LT 96LT & 8LT	 ANSI	Nonsterile Sterile Nonsterile Sterile <i>Quantity: 96 tips/rack, 10 racks/pack, 5 packs/case</i>	VT-20-R VT-20-R-S VT-20-R-LAB* VT-20-R-LAB-S*	
Filtered 	20 µL	96LT & 8LT 96LT & 8LT	 ANSI	Sterile Sterile <i>Quantity: 96 tips/rack, 10 racks/pack, 5 packs/case</i>	VTF-20-R-S VTF-20-R-LAB-S*	
Non-Filtered 	50 µL	96LT & 8LT 96LT & 8LT	 ANSI	Nonsterile Sterile <i>Quantity: 96 tips/rack, 10 racks/pack, 5 packs/case</i>	<i>Coming Soon</i> VT-50-R-LAB* <i>Coming Soon</i> VT-50-R-LAB-S*	
Filtered 	30 µL	96LT & 8LT	 ANSI	Sterile <i>Quantity: 96 tips/rack, 10 racks/pack, 5 packs/case</i>	VTF-30-R-LAB-S*	
Non-Filtered 	250 µL	96LT & 8LT 96LT & 8LT 96LT & 8LT 96LT & 8LT	 ANSI	Nonsterile Sterile Nonsterile Sterile <i>Quantity: 96 tips/rack, 10 racks/pack, 5 packs/case</i>	VT-250-R VT-250-R-S VT-250-R-LAB* VT-250-R-LAB-S*	VT-250-L-R VT-250-L-R-LAB*
Filtered 	165 µL	96LT & 8LT 96LT & 8LT	 ANSI	Sterile Sterile <i>Quantity: 96 tips/rack, 10 racks/pack, 5 packs/case</i>	<i>Coming Soon</i> VTF-165-R-S <i>Coming Soon</i> VTF-165-R-LAB-S*	
Wide-Bore, Non-Filtered 	250 µL	96LT & 8LT	 ANSI	Sterile <i>Quantity: 96 tips/rack, 10 racks/pack, 5 packs/case</i>	<i>Coming Soon</i> VT-255-WB-R-S	
Wide-Bore, Filtered 	165 µL	96LT & 8LT	 ANSI	Sterile <i>Quantity: 96 tips/rack, 10 racks/pack, 5 packs/case</i>	<i>Coming Soon</i> VTF-165-WB-R-S	

* Tip box base sealed for best performance in automated up-and-down stacking.

Format: 384 tip
 Tip Volume Range Selection: 5 µL - 70 µL
 Material: Clear Polypropylene
 Certified RNase-/DNase-free, nonpyrogenic
 Available Options:
 ▶ With or without aerosol-resistant filters
 ▶ Nonsterile or sterilized

Tip Box Format: ANSI
 Material: Conductive Polypropylene for static dissipation

Axygen® Robotic Tips

Type	Max Volume	Compatible Head	Tip Box	Packaging	Standard Cat. No.
Non-Filtered <i>Unique ultra-low volume 5 µL tip for optimal precision.</i>	5 µL	384ST, 96ST, 16ST 384ST, 96ST, 16ST		Nonsterile Sterile <i>Quantity: 384 tips/rack, 10 racks/pack, 5 packs/case</i>	VT-384-5UL-R VT-384-5UL-R-S
Non-Filtered	10 µL	384ST, 96ST, 16ST 84ST, 96ST, 16ST		Nonsterile Sterile <i>Quantity: 384 tips/rack, 10 racks/pack, 5 packs/case</i>	VT-384-10UL-R VT-384-10UL-R-S
Non-Filtered	30 µL	384ST, 96ST, 16ST 384ST, 96ST, 16ST		Nonsterile Sterile <i>Quantity: 384 tips/rack, 10 racks/pack, 5 packs/case</i>	VT-384-31UL-R VT-384-31UL-R-S
Filtered	15 µL	384ST, 96ST, 16ST		Sterile <i>Quantity: 384 tips/rack, 10 racks/pack, 5 packs/case</i>	VTF-384-15UL-R-S
Non-Filtered	70 µL	384ST, 96ST, 16ST 384ST, 96ST, 16ST		Nonsterile Sterile <i>Quantity: 384 tips/rack, 10 racks/pack, 5 packs/case</i>	VT-384-70UL-R VT-384-70UL-R-S
Filtered	50 µL	384ST, 96ST, 16ST		Sterile <i>Quantity: 384 tips/rack, 10 racks/pack, 5 packs/case</i>	VTF-384-50UL-R-S

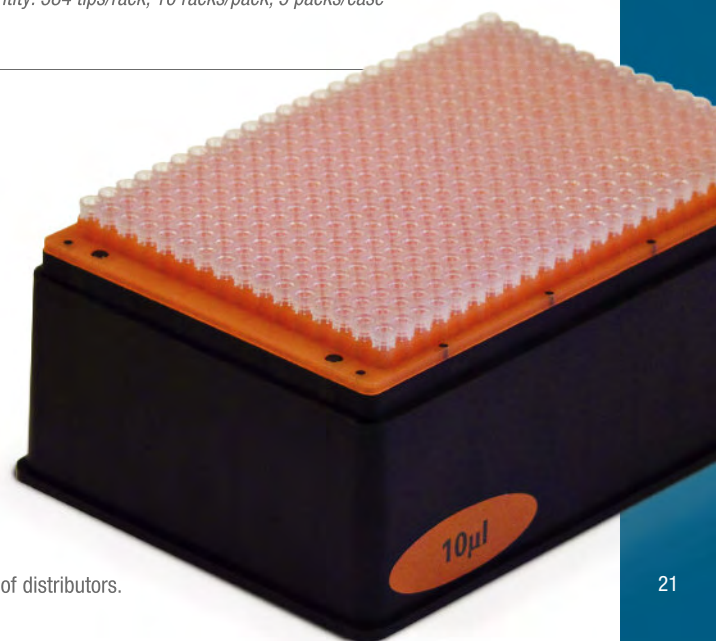

Corning Surface	Applications	Binding Interaction	Sample Properties	Performance Criteria
For Biochemical Assays				
NBS™ polystyrene surface	<ul style="list-style-type: none"> ▶ SPA assays ▶ Homogeneous assays 	None – Inhibits hydrophobic and ionic interactions	Significantly reduces (<2 ng/cm ²) protein and nucleic acid binding	95% reduction of nonspecific binding of protein compared to untreated polystyrene
Medium Binding (untreated) polystyrene surface	<ul style="list-style-type: none"> ▶ Homogeneous and heterogeneous assays 	Hydrophobic	Large biomolecules >20kD with large or abundant hydrophobic regions	384 well clear: Well to well CV ≤ 10% (HT) 384 well black and white: Well to well CV ≤ 15% (HT) Well to well CV ≤ 5% (HO)
High Binding modified polystyrene surface	<ul style="list-style-type: none"> ▶ ELISA and other heterogeneous assays 	Hydrophobic and ionic (negatively charged)	Improves binding of medium to large biomolecules (>10kD) that are positively charged with or without hydrophobic regions.	384 well clear: Well to well CV ≤ 10% 384 well black and white: Well to well CV ≤ 15%
For Cell-based Assays				
Standard tissue culture surface	<ul style="list-style-type: none"> ▶ Assays using standard attachment dependent cell lines 	Hydrophilic and ionic interactions (negatively charged)	Allows cell attachment and binding	≥95% confluency (attachment dependent cell line)
Corning® CellBIND® Surface	<ul style="list-style-type: none"> ▶ Assays for difficult to attach cells ▶ Help cells stay attached during washing steps 	Hydrophilic and ionic interactions (negatively charged)	Enhances cell attachment uniformity and binding to polystyrene	384 well: CV ≤ 20%; Wells with cells/wells without cells – 2X signal from MTS assay
Poly-D-Lysine coated surface	<ul style="list-style-type: none"> ▶ Assays for difficult to attach cells ▶ Help cells stay attached during washing steps 	Hydrophilic and ionic interactions (positively charged)	Enhances cell attachment and binding	384 well: CV ≤ 20%; PDL/TCT ≥ 1.5 serum- free HEK cells

Corning LSE™ Digital Microplate Shaker

The Corning LSE Digital Microplate Shaker features digital control of shaking speed and run time. A single control knob is used to set parameters, and values are shown on a large 3-digit display. A sturdy base encloses the motor for quiet, vibration-free operation.

The included stainless steel platform accommodates up to 4 microplates (standard or deep well) and the shaker is safe for use in temperature controlled environments from 4 to 65°C.

- ▶ Large capacity - process up to 4 microplates
- ▶ 3 mm orbit for resuspending, homogenizing or vortexing
- ▶ Large digital display with single-knob control
- ▶ Suitable for cold room or incubator use



LSE Digital Microplate Shaker Ordering Information

Cat. No.	Description	Voltage	Plug Type	Speed (rpm)	Weight (kg)	Dimensions (cm)	Qty/Cs
6780-4	LSE Digital Microplate Shaker	120V, 50/60Hz	US	100-1400	4.3	16.8 x 27.9 x 15.3	1
6781-4	LSE Digital Microplate Shaker	230V, 50/60Hz	EU	100-1200	4.3	16.8 x 27.9 x 15.3	1
6782-4	LSE Digital Microplate Shaker	230V, 50/60Hz	UK	100-1200	4.3	16.8 x 27.9 x 15.3	1



96 well, solid flat bottom

- ▶ Cell culture microplates are sterilized by gamma radiation and certified nonpyrogenic
- ▶ Designed to reduce well-to-well crosstalk
- ▶ White microplates enhance luminescent signals and have low background luminescence
- ▶ Black microplates have low background fluorescence and minimize light scattering

Cat. No.	Description	Qty/Pk	Qty/Cs
3591	Clear, not treated	1	50
9017	Clear, serocluster, not treated	25	100
3370	Clear, not treated, sterile with lid	20	100
3599	Clear, TC-treated, sterile with lid	1	100
3596	Clear, TC-treated, sterile with lid	1	50
3595	Clear, TC-treated, sterile with low evaporation lid	1	50
3628	Clear, TC-treated, sterile with lid	20	100
3585	Clear, TC-treated, sterile with lid	5	50
3598	Clear, TC-treated, sterile with lid	5	100
3300	Clear, Corning CellBIND® Surface, sterile with lid	5	50
3841	Clear, Poly-D-Lysine, sterile with lid***	25	100
3474	Clear, Ultra-Low Attachment Surface, sterile with lid	1	24
3641	Clear, NBS	25	100
3361	Clear, High Bind, sterile with lid	20	100

Cat. No.	Description	Qty/Pk	Qty/Cs
3590	Clear, High Bind	1	100
9018	Clear, High Bind	25	100
2507	Clear, Carbo-BIND™	25	50
2509	Clear, Sulfhydryl-BIND™	25	50
2503	Clear, Universal-BIND™	25	50
3912	White, not treated	25	100
3917	White, TC-treated, sterile with lid	20	100
3362	White, TC-treated, sterile	25	100
3600	White, NBS	25	100
3922	White, Half Area, NBS	25	100
3915	Black, not treated	25	100
3916	Black, TC-treated, sterile with lid	20	100
3650	Black, NBS	25	100
3925	Black, High Bind	25	100

Well Vol. (µL)	Well Depth (mm)	Well Diameter (mm)	Plate Length (mm)	Plate width (mm)	Plate Height (mm)	A1 Row offset (mm)	Well Center A1 column offset (mm)	Flange or to center (mm)	Stack skirt height (mm)	Well Bottom height (mm)	Well Bottom elevation (mm)	Well Bottom Thickness (mm)	Bottom Area (cm ²)
360	10.67	6.86/6.35	127.8	85.5	14.2	11.2	14.3	9	6.096	12.97	3.53	1.27	0.3165

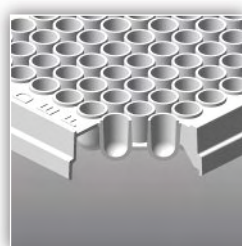

96 well, round bottom

- ▶ Cell culture microplates are sterilized by gamma radiation and certified nonpyrogenic
- ▶ Designed to reduce well-to-well crosstalk
- ▶ White microplates enhance luminescent signals and have low background luminescence
- ▶ Black microplates have low background fluorescence and minimize light scattering

Cat. No.	Description	Qty/Pk	Qty/Cs
3367	Clear, not treated, sterile	1	50
3788	Clear, not treated, sterile with lid	20	100
3795	Clear, not treated, sterile	25	100
3797	Clear, not treated	25	100
3798	Clear, processed for improved hydrophilicity	25	100
3799	Clear, TC-treated, sterile	1	50

Cat. No.	Description	Qty/Pk	Qty/Cs
3360	Clear, TC-treated, sterile	25	100
3366	Clear, High Bind	25	100
7007	Clear, Ultra-Low Attachment Surface, sterile with lid	1	24
3789	White, not treated	25	100
3605	White, NBS	25	100
3792	Black, not treated	25	100

Well Vol. (µL)	Well Depth (mm)	Well Diameter (mm)	Plate Length (mm)	Plate width (mm)	Plate Height (mm)	A1 Row offset (mm)	Well Center A1 column offset (mm)	Flange or to center (mm)	Stack skirt height (mm)	Well Bottom height (mm)	Well Bottom elevation (mm)	Well Bottom Thickness (mm)	Bottom Area (cm ²)
360	11.3	6.86/6.35	127.8	85.5	14.2	11.2	14.3	9	6.096	13.04	3.53	1.14	NA

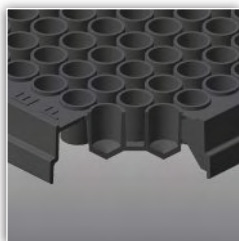

96 well, V-bottom

- ▶ Not treated (or medium binding) polystyrene surface is hydrophobic in nature and binds biomolecules through passive interactions
- ▶ Is suitable primarily for the immobilization of large molecules, such as antibodies, that have large hydrophobic regions that can interact with the surface
- ▶ Untreated microplates have a binding capacity of approximately 100 to 200ng IgG/cm²

Cat. No.	Description	Qty/Pk	Qty/Cs	Cat. No.	Description	Qty/Pk	Qty/Cs
3896	Clear, not treated, sterile	1	48	3898	Clear, processed for improved hydrophilicity	25	100
3897	Clear, not treated	25	100	3894	Clear, TC-treated, sterile with lid	1	50

Well Vol. (μL)	Well Depth (mm)	Well Diameter (mm)	Plate Length (mm)	Plate width (mm)	Plate Height (mm)	A1 Row offset (mm)	Well Center A1 column offset (mm)	Flange or to center (mm)	Stack skirt height (mm)	Well Bottom height (mm)	Well Bottom elevation (mm)	Well Bottom Thickness (mm)	Bottom Area (cm ²)
320	11.12	6.86/6.37	127.8	85.5	14.2	11.2	14.3	9	6.096	13.04	4.29	NA	NA

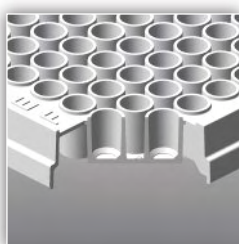

96 well, Easy Wash bottom

- ▶ Easy Wash design (round to narrowed flat well bottom) for improved washing in immunoassays
- ▶ Not treated (or medium binding) polystyrene surface is hydrophobic in nature and binds biomolecules through passive interactions
- ▶ Is suitable primarily for the immobilization of large molecules, such as antibodies, that have large hydrophobic regions that can interact with the surface
- ▶ Not treated microplates have a binding capacity of approximately 100 to 200ng IgG/cm²
- ▶ High binding surface binds medium (>10kD) and large biomolecules that possess ionic groups and/or hydrophobic regions with a binding capacity of approximately 500ng of mouse IgG/cm²

Cat. No.	Description	Qty/Pk	Qty/Cs	Cat. No.	Description	Qty/Pk	Qty/Cs
3368	Clear, not treated	25	100	3369	Clear, High Bind	25	100

Well Vol. (μL)	Well Depth (mm)	Well Diameter (mm)	Plate Length (mm)	Plate width (mm)	Plate Height (mm)	A1 Row offset (mm)	Well Center A1 column offset (mm)	Flange or to center (mm)	Stack skirt height (mm)	Well Bottom height (mm)	Well Bottom elevation (mm)	Well Bottom Thickness (mm)	Bottom Area (cm ²)
360	10.67	6.86/4.57	127.8	85.5	14.2	11.2	14.3	9	6.096	13.02	3.55	1.27	0.1639

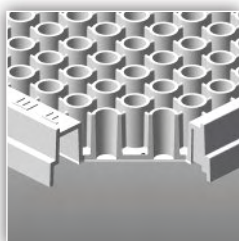

96 well, flat clear bottom

- ▶ Bottoms are 60% thinner than conventional polystyrene microplates, resulting in lower background fluorescence and enabling readings down to 340 nm
- ▶ Opaque walls prevent well-to-well crosstalk
- ▶ Optically clear flat bottom permits direct microscopic viewing

Cat. No.	Description	Qty/Pk	Qty/Cs	Cat. No.	Description	Qty/Pk	Qty/Cs
3632	White, not treated	25	100	3904	Black, TC-treated, sterile with lid	20	100
3610	White, TC-treated, sterile with lid	1	48	3651	Black, NBS	25	100
3903	White, TC-treated, sterile with lid	20	100	3340	Black, Corning CellBIND® Surface, sterile with lid	5	50
3604	White, NBS	25	100	3842	Black, Poly-d-Lysine, sterile with lid	25	100
3843	White, Poly-d-Lysine, sterile with lid	25	100	3601	Black, High Bind	25	100
3631	Black, not treated	25	100	3635	Clear, Acrylic Copolymer, not treated	25	50
3603	Black, TC-treated, sterile with lid	1	48				

Well Vol. (μL)	Well Depth (mm)	Well Diameter (mm)	Plate Length (mm)	Plate width (mm)	Plate Height (mm)	A1 Row offset (mm)	Well Center A1 column offset (mm)	Flange or to center (mm)	Stack skirt height (mm)	Well Bottom height (mm)	Well Bottom elevation (mm)	Well Bottom Thickness (mm)	Bottom Area (cm ²)
360	10.67	6.86/6.35	127.8	85.5	14.2	11.2	14.3	9	6.096	13.12	3.57	0.5	0.3165

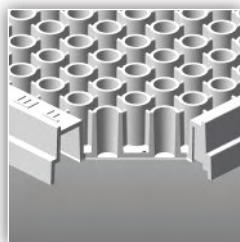

96 well, Half Area, UV

- ▶ Certified DNase- and RNase-free
- ▶ UV-transparent bottom is molded directly to an acrylic base for greater strength and maximum leak resistance
- ▶ Working volume of 25 to 125 µL
- ▶ Allows UV absorbance readings with low background, especially at 260 to 280 nm
- ▶ Well spacing is identical to standard 96 well plates, allowing easy transition using existing automation

Cat. No.	Description	Qty/Pk	Qty/Cs
3679	Clear, UV	25	100

Well Vol. (µL)	Well Depth (mm)	Well Diameter (mm)	Plate Length (mm)	Plate width (mm)	Plate Height (mm)	A1 Row offset (mm)	Well Center A1 column offset (mm)	Flange or to center (mm)	Stack skirt height (mm)	Well Bottom height (mm)	Well Bottom elevation (mm)	Well Bottom Thickness (mm)	Bottom Area (cm ²)
205	11.47	5.0/4.5	127.8	85.5	14.2	11.2	14.3	9	6.096	12.49	2.75	0.381	0.1586

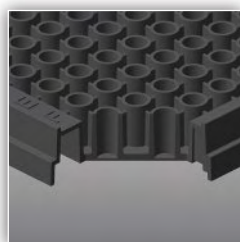

96 well, Half Area, solid

- ▶ Designed to reduce well-to-well crosstalk
- ▶ White microplates enhance luminescent signals and have low background luminescence
- ▶ Black microplates have low background fluorescence and minimize light scattering
- ▶ Well spacing is identical to standard 96 well plates, allowing easy transition using existing automation

Cat. No.	Description	Qty/Pk	Qty/Cs
3695	Clear, Half Area, not treated	25	100
3697	Clear, Half Area, TC-treated, sterile with lid	25	100
3690	Clear, Half Area, High Bind	25	100
3693	White, Half Area, not treated	25	100
3688	White, Half Area, TC-treated, sterile with lid	20	100

Cat. No.	Description	Qty/Pk	Qty/Cs
3696	White, Half Area, TC-treated, sterile with lid	1	50
3694	Black, Half Area, not treated	25	100
3875	Black, Half Area, TC-treated, sterile with lid	25	100
3686	Black, Half Area, NBS	25	100

Well Vol. (µL)	Well Depth (mm)	Well Diameter (mm)	Plate Length (mm)	Plate width (mm)	Plate Height (mm)	A1 Row offset (mm)	Well Center A1 column offset (mm)	Flange or to center (mm)	Stack skirt height (mm)	Well Bottom height (mm)	Well Bottom elevation (mm)	Well Bottom Thickness (mm)	Bottom Area (cm ²)
190	10.54	5.0/4.50	127.8	85.5	14.2	11.2	14.3	9	6.096	12.96	2.28	1.27	0.1586

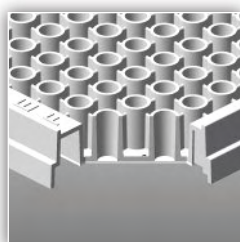

96 well, Half Area, clear flat bottom

- ▶ Bottoms are 70% thinner than conventional polystyrene microplates, resulting in lower background fluorescence and enabling readings down to 340 nm
- ▶ Opaque walls prevent well-to-well crosstalk
- ▶ Optically clear flat bottom permits direct microscopic viewing
- ▶ Well spacing is identical to standard 96 well plates, allowing easy transition using existing automation

Cat. No.	Description	Qty/Pk	Qty/Cs
3883	White, Half Area, not treated	25	100
3885	White, Half Area, TC-treated, sterile with lid	20	100
3886	White, Half Area, TC-treated, sterile with lid	25	100
3884	White, Half Area, NBS	25	100

Cat. No.	Description	Qty/Pk	Qty/Cs
3880	Black, Half Area, not treated	25	100
3882	Black, Half Area, TC-treated, sterile with lid	20	100
3887	Black, Half Area, TC-treated, sterile	25	100
3881	Black, Half Area, NBS	25	100

Well Vol. (µL)	Well Depth (mm)	Well Diameter (mm)	Plate Length (mm)	Plate width (mm)	Plate Height (mm)	A1 Row offset (mm)	Well Center A1 column offset (mm)	Flange or to center (mm)	Stack skirt height (mm)	Well Bottom height (mm)	Well Bottom elevation (mm)	Well Bottom Thickness (mm)	Bottom Area (cm ²)
205	11.47	5.0/4.5	127.8	85.5	14.2	11.2	14.3	9	6.096	12.49	2.75	0.381	0.1586

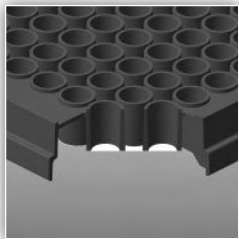

96 well, Special Optics, clear bottom

- ▶ Bottoms are 90% thinner than conventional polystyrene microplates, resulting in lower background fluorescence and enabling readings down to 340 nm
- ▶ Opaque walls prevent well-to-well crosstalk
- ▶ Optically clear flat bottom permits direct microscopic viewing

Cat. No.	Description	Qty/Pk	Qty/Cs
3615	Black, Special Optics, with lid	20	100
3720	Black, Special Optics, TC-treated, sterile	5	25
3614	Black, Special Optics, TC-treated, sterile	20	100

Well Vol. (μL)	Well Depth (mm)	Well Diameter (mm)	Plate Length (mm)	Plate width (mm)	Plate Height (mm)	A1 Row offset (mm)	Well Center A1 column offset (mm)	Flange or to center (mm)	Stack skirt height (mm)	Well Bottom height (mm)	Well Bottom elevation (mm)	Well Bottom Thickness (mm)	Bottom Area (cm ²)
360	10.67	6.86/6.35	127.8	85.5	14.2	11.2	14.3	9	6.096	13.12	2.75	0.127	0.3165

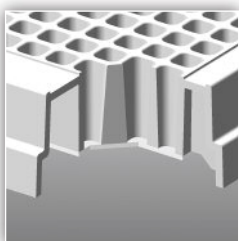

384 well, clear flat bottom

- ▶ Suited for fluorescent and luminescent assays using either top or bottom detection microplate readers

Cat. No.	Description	Qty/Pk	Qty/Cs
3706	White, not treated	25	100
3707	White, TC-treated, sterile with lid	20	100
3653	White, NBS	25	100
3846	White, Poly-D-Lysine, sterile with lid	25	100

Cat. No.	Description	Qty/Pk	Qty/Cs
3711	Black, not treated	25	100
3712	Black, TC-treated, sterile with lid	20	100
3683	Black, Corning CellBIND® Surface	10	50
3655	Black, NBS	25	100
3845	Black, Poly-D-Lysine, sterile with lid	25	100
3985	Black, Optical imaging, thick bottom, TC-treated, sterile	20	100

Well Vol. (μL)	Well Depth (mm)	Well Diameter (mm)	Plate Length (mm)	Plate width (mm)	Plate Height (mm)	A1 Row offset (mm)	A1 column offset (mm)	Well Center to center (mm)	Flange or skirt height (mm)	Stack height (mm)	Well Bottom elevation (mm)	Well Bottom Thickness (mm)
112	11.43	3.63/2.67	127.8	85.5	14.2	8.99	12.12	4.5	6.10	13.51	2.79	1.27

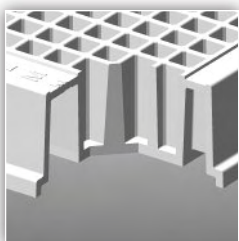

384 well, solid, low flange, flat bottom

- ▶ Working well volume of 20 to 80 μL
- ▶ Cell culture microplates are sterilized by gamma radiation and certified nonpyrogenic

Cat. No.	Description	Qty/Pk	Qty/Cs
3572	White, not treated	10	50
3570	White, TC-treated, sterile with lid	10	50
3574	White, NBS	10	50

Cat. No.	Description	Qty/Pk	Qty/Cs
3573	Black, not treated	10	50
3571	Black, TC-treated, sterile with lid	10	50
3575	Black, NBS	10	50

Well Vol. (μL)	Well Depth (mm)	Well Diameter (mm)	Plate Length (mm)	Plate width (mm)	Plate Height (mm)	A1 Row offset (mm)	A1 column offset (mm)	Well Center to center (mm)	Flange or skirt height (mm)	Stack height (mm)	Well Bottom elevation (mm)	Well Bottom Thickness (mm)
112	11.43	3.63/2.82	127.8	85.5	14.2	8.99	12.12	4.5	2.41	12.95	2.79	1.4

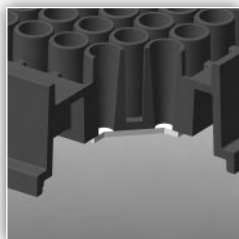

384 well, solid and clear flat bottom, low volume

- ▶ Designed to reduce well-to-well crosstalk during fluorescent and luminescent assays
- ▶ Suited for fluorescent and luminescent assays using either top or bottom detection microplate readers

Cat. No.	Description	Qty/Pk	Qty/Cs
3825	White, solid flat bottom, not treated	10	50
3826	White, solid flat bottom, TC-treated, sterile with lid	10	50
3824	White, solid flat bottom, NBS	10	50
3821	Black, solid flat bottom, not treated	10	50
3822	Black, solid flat bottom, TC-treated, sterile with lid	10	50
3820	Black, solid flat bottom, NBS	10	50

Cat. No.	Description	Qty/Pk	Qty/Cs
3540	Black, clear flat bottom, not treated	10	50
3542	Black, clear flat bottom, TC-treated, sterile with lid	10	50
3544	Black, clear flat bottom, NBS	10	50
3643	Black, clear flat bottom, Poly-D-Lysine	10	50

Well Vol. (µL)	Well Depth (mm)	Well Diameter (mm)	Plate Length (mm)	Plate width (mm)	Plate Height (mm)	A1 Row offset (mm)	A1 column offset (mm)	Well Center to center (mm)	Flange or skirt height (mm)	Stack height (mm)	Well Bottom elevation (mm)	Well Bottom Thickness (mm)
50	9.39	3.30/2.00	127.8	85.5	12.19	8.99	12.12	4.5	2.41	10.49	2.79	0.64

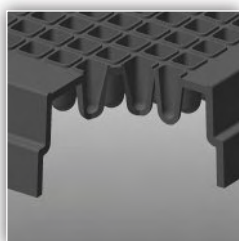

384 well, round bottom, low volume

- ▶ Designed to reduce well-to-well crosstalk during fluorescent and luminescent assays

Cat. No.	Description	Qty/Pk	Qty/Cs
3673	White, NBS	25	100
3674	White, not treated	25	100

Cat. No.	Description	Qty/Pk	Qty/Cs
3677	Black, not treated	25	100
3676	Black, NBS	25	100
3678	Black, High Bind	25	100

Well Vol. (µL)	Well Depth (mm)	Well Diameter (mm)	Plate Length (mm)	Plate width (mm)	Plate Height (mm)	A1 Row offset (mm)	A1 column offset (mm)	Well Center to center (mm)	Flange or skirt height (mm)	Stack height (mm)	Well Bottom elevation (mm)	Well Bottom Thickness (mm)
35	6.58	3.30/2.03	127.8	85.5	14.2	8.99	12.12	4.5	6.10	12.84	8.15	.09

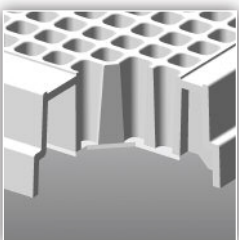

384 well, solid clear, flat bottom

- ▶ Working well volume of 20 to 80 µL
- ▶ Cell culture microplates are sterilized by gamma radiation and certified nonpyrogenic
- ▶ The 384 well Universal Optics NBS™ microplate is manufactured using an advanced polymer with high clarity and improved chemical resistant properties.

Cat. No.	Description	Qty/Pk	Qty/Cs
3640	Clear, NBS	25	100
3640BC	Clear, NBS, with bar code labels	25	100
3844	Clear, Poly-D-Lysine, sterile* with lid	20	100
3680	Clear, not treated, sterile with lid	20	100
3700	Clear, High Bind	25	100

Cat. No.	Description	Qty/Pk	Qty/Cs
3701	Clear, TC-treated, sterile with lid	20	100
3702	Clear, not treated	25	100
3702BC	Clear, not treated, with bar code labels	25	100
3723	Clear, NBS, Universal Optics	25	100

*Aseptically manufactured.

Well Vol. (µL)	Well Depth (mm)	Well Diameter (mm)	Plate Length (mm)	Plate width (mm)	Plate Height (mm)	A1 Row offset (mm)	A1 column offset (mm)	Well Center to center (mm)	Flange or skirt height (mm)	Stack height (mm)	Well Bottom elevation (mm)	Well Bottom Thickness (mm)
112	11.43	3.63/2.67	127.8	85.5	14.2	8.99	12.12	4.5	6.10	13.51	2.79	1.27

Corning® Polystyrene 1536 Well Microplates

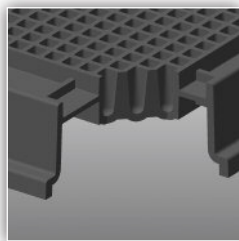

1536 well, solid, round bottom

- ▶ Recommended working volume of up to 8 µL
- ▶ Round well bottoms for reduced air entrapment and improved CVs and Z factor
- ▶ Raised well bottoms for higher sensitivity
- ▶ Flood reservoir on four sides to reduce instrument contamination

Cat. No.	Description	Qty/Pk	Qty/Cs	Cat. No.	Description	Qty/Pk	Qty/Cs
3937	White, not treated	10	50	3936	Black, not treated	10	50

Well Vol. (µL)	Well Depth (mm)	Well Diameter (mm)	Plate Length (mm)	Plate width (mm)	Plate Height (mm)	A1 Row offset (mm)	A1 column offset (mm)	Well Center to center (mm)	Flange or skirt height (mm)	Stack height (mm)	Well Bottom elevation (mm)	Well Bottom Thickness (mm)
10	5.01	1.69/0.74	127.8	85.5	10.4	7.86	11	2.25	2.16	8.7	5.41	0.9

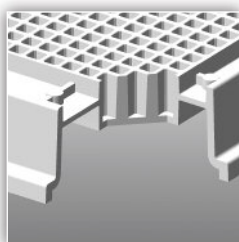

1536 well, solid, flat bottom

- ▶ Recommended working volume of up to 8 µL
- ▶ Raised well bottoms for higher sensitivity
- ▶ Flood reservoir on four sides to reduce instrument contamination

Cat. No.	Description	Qty/Pk	Qty/Cs	Cat. No.	Description	Qty/Pk	Qty/Cs
3725	White, not treated	10	50	3724	Black, not treated	10	50
3727	White, TC-treated, sterile with lid	10	50	3726	Black, TC-treated, sterile with lid	10	50
3729	White, NBS	10	50	3728	Black, NBS	10	50

Well Vol. (µL)	Well Depth (mm)	Well Diameter (mm)	Plate Length (mm)	Plate width (mm)	Plate Height (mm)	A1 Row offset (mm)	A1 column offset (mm)	Well Center to center (mm)	Flange or skirt height (mm)	Stack height (mm)	Well Bottom elevation (mm)	Well Bottom Thickness (mm)
12.8	4.95	1.8/1.63	127.8	85.5	10.4	7.86	11	2.25	2.16	8.9	5.45	0.91

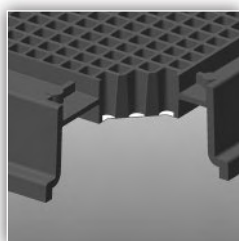

1536 well, flat clear bottom, high base

- ▶ Recommended working volume of up to 8 µL
- ▶ Raised well bottoms for higher sensitivity
- ▶ Flood reservoir on four sides to reduce instrument contamination

Cat. No.	Description	Qty/Pk	Qty/Cs
3891	Black, not treated	10	50
3893	Black, TC-treated, sterile with lid	10	50
3895	Black, NBS	10	50

Well Vol. (µL)	Well Depth (mm)	Well Diameter (mm)	Plate Length (mm)	Plate width (mm)	Plate Height (mm)	A1 Row offset (mm)	A1 column offset (mm)	Well Center to center (mm)	Flange or skirt height (mm)	Stack height (mm)	Well Bottom elevation (mm)	Well Bottom Thickness (mm)
12.8	4.8	1.8/1.63	127.8	85.5	10.4	7.86	11	2.25	2.16	8.9	5.6	0.08

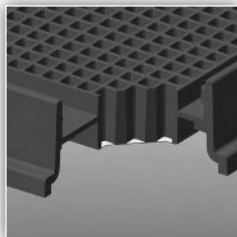

1536 well, flat clear bottom, low base

- ▶ Recommended working volume of up to 8 µL
- ▶ Low base designed for optimal bottom reader sensitivity

Cat. No.	Description	Qty/Pk	Qty/Cs
3831	Black, not treated	10	50
3832	Black, Corning® CellBIND® Surface, sterile with lid	10	50
3838	Black, TC-treated, sterile with lid	10	50

Well Vol. (µL)	Well Depth (mm)	Well Diameter (mm)	Plate Length (mm)	Plate width (mm)	Plate Height (mm)	A1 Row offset (mm)	A1 column offset (mm)	Well Center to center (mm)	Flange or skirt height (mm)	Stack height (mm)	Well Bottom elevation (mm)	Well Bottom Thickness (mm)
12.5	6.2	1.78/1.51	127.8	85.5	10.4	7.86	11	2.25	2.16	8.9	1.8	0.08

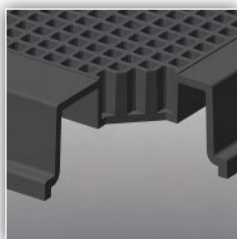

1536 well, solid, smooth top, high base

- ▶ Recommended working volume of up to 7.5 µL
- ▶ No logo or lettering for improved heat sealing and ease of liquid handling
- ▶ Raised well bottoms for higher sensitivity

Cat. No.	Description	Qty/Pk	Qty/Cs
7247	White, not treated	10	50
7249	White, TC-treated	10	50

Cat. No.	Description	Qty/Pk	Qty/Cs
7246	Black, not treated	10	50
7248	Black, TC-treated	10	50

Well Vol. (µL)	Well Depth (mm)	Well Diameter (mm)	Plate Length (mm)	Plate width (mm)	Plate Height (mm)	A1 Row offset (mm)	A1 column offset (mm)	Well Center to center (mm)	Flange or skirt height (mm)	Stack height (mm)	Well Bottom elevation (mm)	Well Bottom Thickness (mm)
10	5.01	1.69/0.74	127.8	85.5	10.4	7.86	11	2.25	2.16	8.7	5.41	0.9

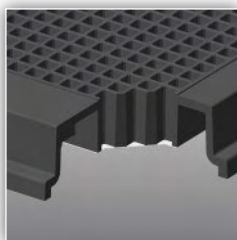

1536 well, clear bottom, smooth top, low base

- ▶ Recommended working volume of up to 8 µL
- ▶ No logo or lettering for improved heat sealing and ease of liquid handling
- ▶ Low base designed for optimal bottom reader sensitivity

Cat. No.	Description	Qty/Pk	Qty/Cs
3833	Black, Corning CellBIND Surface, sterile	20	100
3835	Black, not treated	20	100
3836	Black, TC-treated, sterile	20	100

Well Vol. (µL)	Well Depth (mm)	Well Diameter (mm)	Plate Length (mm)	Plate width (mm)	Plate Height (mm)	A1 Row offset (mm)	A1 column offset (mm)	Well Center to center (mm)	Flange or skirt height (mm)	Stack height (mm)	Well Bottom elevation (mm)	Well Bottom Thickness (mm)
12.8	4.95	1.8/1.63	127.8	85.5	8	7.86	11	2.25	2.16	6.2	1.8	0.08

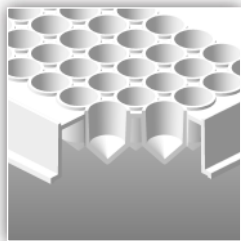

96 well, Corning

- ▶ Flat or V-shaped well bottom
- ▶ Feature uniform skirt heights for greater robotic gripping surface
- ▶ Solvent resistant polypropylene provides compatibility with many common organic solvents (e.g., DMSO, ethanol, methanol)
- ▶ Certified DNase- and RNase-free
- ▶ Available sterile or nonsterile

Cat. No.	Description	Qty/Pk	Qty/Cs
3364	Flat bottom, not treated	25	100
3357	V-bottom, not treated, sterile	25	100
3363	V-bottom, not treated	25	100

Cat. No.	Description	Qty/Pk	Qty/Cs
3343	Expanded volume, flat bottom, not treated	10	50
3344	Expanded volume, flat bottom, not treated, sterile	10	50

Well Vol. (μL)	Well Depth (mm)	Well Diameter (mm)	Plate Length (mm)	Plate width (mm)	Plate Height (mm)	A1 Row offset (mm)	A1 column offset (mm)	Well Center to center (mm)
360	10.67	6.86 / 6.35	127.8	85.5	14.2	11.2	14.3	9

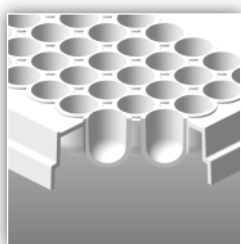

96 well, Axygen

- ▶ Round or V-shaped well bottom
- ▶ Feature uniform skirt heights for greater robotic gripping surface
- ▶ Solvent resistant polypropylene provides compatibility with many common organic solvents (e.g., DMSO, ethanol, methanol)
- ▶ Certified DNase- and RNase-free
- ▶ Available sterile or nonsterile

Cat. No.	Description	Qty/Pk	Qty/Cs
P-96-450R-C	500 μL, round bottom, ANSI footprint	10	50
P-96-450V-C	500 μL, V-bottom, ANSI footprint	10	50

Well Vol. (μL)	Well Depth (mm)	Well Diameter (mm)	Plate Length (mm)	Plate width (mm)	Plate Height (mm)	A1 Row offset (mm)	A1 column offset (mm)	Well Center to center (mm)
360	10.67	6.86 / 6.35	127.8	85.5	14.2	11.2	14.3	9

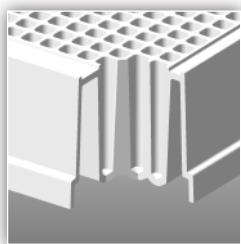

384 well, Corning

- ▶ Resistant to many common organic solvents (e.g., DMSO, ethanol, methanol)
- ▶ Certified DNase- and RNase-free

Cat. No.	Description	Qty/Pk	Qty/Cs
3342	V-bottom, not treated, sterile	5	50
3347	V-bottom, not treated	5	25

Well Vol. (μL)	Well Depth (mm)	Well Diameter (mm)	Plate Length (mm)	Plate width (mm)	Plate Height (mm)	A1 Row offset (mm)	A1 column offset (mm)	Well Center to center (mm)
180	22.4	3.58 / 3.23	127.3	85.3	24.94	8.94	11.94	4.5

Manufacturer	Model	Format	Epic® 384 well	96 Well Polystyrene	384 Well Polystyrene	1536 Well Polystyrene	96 well Polypropylene	384 Well Polypropylene
Aurora Biomed	Versa®	96		○	○		○	○
BioTek®	Precision™	96		●	●		●	●
	Precision XS	96		●	●		●	●
Dynamic Devices	Oasis LM	96		○	○	○	○	○
	Oasis LM	384	●		○	○		○
Hamilton®	Microlab® STAR	384	●		●	●	●	●
	Microlab STARlet	384	●		●	●	●	●
	Microlab STARplus	384	●		●	●	●	●
ProGroup Wellpro	3000-96	96		○	○		○	○
	3000-384	384	●		○			○
Tecan®	Freedom EVO®	96		○	○	○	○	○
	Aquarius	96		○	○	○	○	○
	Genesis Freedom®	96		○	○	○	○	○
	Miniprep w/ LIHA	96		○	○	○	○	○
	TEMO	96		○	○	○	○	○
Zymark®/Caliper	RapidPlate®	96		●	●	●	●	●
	SciClone®	96		●	●	●	●	●
	Zephyr®	96		●	●		●	●
Agilent / Velocity11®	Bravo®	96		●	●	●	●	●
	Bravo	384	●		●	●		●
	VPrep®	96		●	●	●	●	●
	VPrep	384	●		●	●		●
Beckman Coulter®	Biomek® 1000	96		●	●		●	●
	Biomek 2000	96		●	●		●	●
	Biomek 3000	96		●	●	●	●	●
	BioMek FX	96		●	●	●	●	●
	BioMek FX	384	●	●	●	●	●	●
	BioMek FX with SPAN-8	96		●	●	●	●	●
	Biomek NX	96		●	●	●	●	●
	Biomek NX	384	●		●	●		●
	BioMek NX with SPAN-8	96		●	●	●	●	●
	Multimek™	96		●	●	●	●	●
Multimek	384	●		●	●		●	
Sagian	Multipette	96		○	○	○	○	○
PerkinElmer®	Evolution P³	96		●	●	●	●	●
	Evolution P³	384	●		●	●		●
	Janus®	96		●	●	●	●	●
	Janus	384	●		●	●		●
	MiniTrak	96		●	●	●	●	●
	MiniTrak	384	●		●	●		●
	MultiProbe	96		●	●	●	●	●
	PlateTrak®	96		●	●	●	●	●
PlateTrak	384	●		●	●		●	
QIAGEN	BioRobot®	96		○	○		○	○

- Confirmed compatibility with equipment manufacturer
- ANSI-compliant microplates
- Confirmed compatibility with like equipment from same manufacturer

Format: 384 tip
 Tip Volume Range Selection: 25 µL - 50 µL
 Material: Clear polypropylene
 Certified RNase-/DNase-free, nonpyrogenic
 Available Options:
 ▶ With or without aerosol-resistant filters
 ▶ Nonsterile or sterilized
 ▶ Standard or MAXIMUM RECOVERY®

Tip Box Format: ANSI
 Material: Number 5 Polypropylene

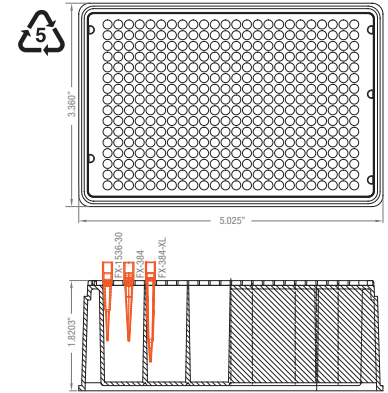

Axygen® Robotic Tips

Type	Max Volume	Compatible Head	Tip Box	Packaging	Standard Cat. No.	MAXIMUM RECOVERY Cat. No.
Non-Filtered	27 µL	AP-384		Nonsterile Sterile Quantity: 384 tips/rack, 10 racks/pack, 5 packs/case	FX-1536-30FP-R FX-1536-30FP-R-S	
Non-Filtered	50 µL	AP-384		Nonsterile Sterile Quantity: 384 tips/rack, 10 racks/pack, 5 packs/case	FX-384-XL-R FX-384-XL-R-S	FX-384-XL-L-R FX-384-XL-L-R-S
Filtered	30 µL	AP-384		Sterile Quantity: 384 tips/rack, 10 racks/pack, 5 packs/case	FXF-384-XL-R-S	FXF-384-XL-L-R-S
Non-Filtered	30 µL	AP-384		Nonsterile Sterile Quantity: 384 tips/rack, 10 racks/pack, 5 packs/case	FX-384-R FX-384-R-S	FX-384-L-R FX-384-L-R-S
Filtered	25 µL	AP-384		Sterile Quantity: 384 tips/rack, 10 racks/pack, 5 packs/case	FXF-384-R-S	FXF-384-L-R-S

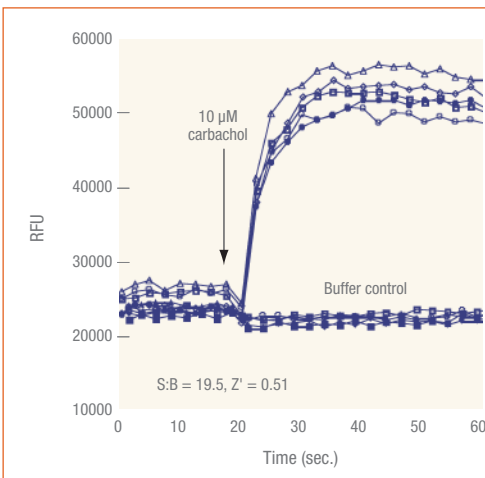

Miniaturization of Calcium Mobilization Assay in Corning® 384 Well Low Volume Black Clear Bottom Tissue Culture Treated Microplate (Cat. No. 3542)

The chromatograms shown here are the rapid increase of calcium signals in transfected CHO-K1 cells upon the addition of carbachol (n=5 wells). M1WT2 cells (ATCC, CRL-1984), derived from CHO-K1 cells transfected with the rat muscarinic acetylcholine receptor, were seeded at 5,000 cells per well in 10 µL medium and then grown in CO₂ incubator overnight (37°C). After the addition of 10 µL calcium dye solution per well, the microplates were incubated at 37°C for 30 minutes. After equilibrating to RT for 30 minutes, microplates were loaded into a Flexstation® reader (Molecular Devices, Inc.). Five µL of 50 µM carbachol solution (final concentration 10 µM) was transferred to induce the response (or 5 µL of buffer for the negative controls). The calcium signal was monitored for 60 seconds. Assay was performed with Calcium 3 kit (Molecular Devices, Inc.).

Format: 96 tip
 Tip Volume Range Selection: 5 µL - 250 µL
 Material: Clear polypropylene
 Certified RNase-/DNase-free, nonpyrogenic
 Available Options:

- ▶ With or without aerosol-resistant filters
- ▶ Nonsterile or sterilized
- ▶ Standard or MAXIMUM RECOVERY®

Tip Box Format: ANSI
 Material: Number 5 Polypropylene

Axygen® Robotic Tips

Type	Max Volume	Compatible Head	Tip Box	Packaging	Standard Cat. No.	MAXIMUM RECOVERY Cat. No.
	20 µL	AP-96, SPAN-8 MP20	 	Nonsterile Sterile Quantity: 96 tips/rack, 10 racks/pack, 5 packs/case	FX-10-R FX-10-R-S	
	5 µL	AP-96, SPAN-8 MP20	 	Sterile Quantity: 96 tips/rack, 10 racks/pack, 5 packs/case	FXF-10-R-S	
	100 µL	AP-96, SPAN-8 MP20	 	Nonsterile Sterile Quantity: 96 tips/rack, 10 racks/pack, 5 packs/case	FX-20-R FX-20-R-S	FX-20-L-R FX-20-L-R-S
	20 µL	AP-96, SPAN-8 MP20	 	Sterile Quantity: 96 tips/rack, 10 racks/pack, 5 packs/case	FXF-20-R-S	FXF-20-L-R-S
	50 µL	AP-96, SPAN-8 MP20, MP200	 	Nonsterile Sterile Quantity: 96 tips/rack, 10 racks/pack, 5 packs/case	FX-50-R FX-50-R-S	FX-50-L-R FX-50-L-R-S
	30 µL	AP-96, SPAN-8 MP20, MP200	 	Sterile Quantity: 96 tips/rack, 10 racks/pack, 5 packs/case	FXF-50-R-S	FXF-50-L-R-S
	250 µL	AP-96, SPAN-8 MP200	 	Nonsterile Sterile Quantity: 96 tips/rack, 10 racks/pack, 5 packs/case	FX-250-R FX-250-R-S	FX-250-L-R FX-250-L-R-S
	165 µL 200 µL	AP-96, SPAN-8 MP200	 	Sterile Sterile Quantity: 96 tips/rack, 10 racks/pack, 5 packs/case	FXF-180-R-S FXF-200-R-S 	FXF-180-L-R-S
	250 µL	AP-96, SPAN-8 MP200	 	Nonsterile Sterile Quantity: 96 tips/rack, 10 racks/pack, 5 packs/case	FX-255-WB-R FX-255-WB-R-S	
	165 µL	AP-96, SPAN-8 MP200	 	Sterile Quantity: 96 tips/rack, 10 racks/pack, 5 packs/case	FXF-165-WB-R-S	

Format: 96 tip
 Tip Volume Range Selection: 20 µL - 250 µL
 Material: Conductive LLS Black Polypropylene
 Certified RNase-/DNase-free, nonpyrogenic
 Available Options:
 ▶ With or without aerosol-resistant filters
 ▶ Nonsterile or sterilized

Tip Box Format: ANSI
 Material: Number 5 Polypropylene

Axygen® Robotic Tips

Type	Max Volume	Compatible Head	Tip Box	Packaging	Standard Cat. No.
 Conductive, Non-Filtered	100 µL	SPAN-8	 ANSI	Nonsterile Sterile Quantity: 96 tips/rack, 10 racks/pack, 5 packs/case	SPN-20-CBK-R SPN-20-CBK-R-S
 Conductive, Filtered	20 µL	SPAN-8	 ANSI	Sterile Quantity: 96 tips/rack, 10 racks/pack, 5 packs/case	SPNF-20-CBK-R-S
 Conductive, Non-Filtered	50 µL	SPAN-8	 ANSI	Nonsterile Sterile Quantity: 96 tips/rack, 10 racks/pack, 5 packs/case	SPN-50-CBK-R SPN-50-CBK-R-S
 Conductive, Filtered	30 µL	SPAN-8	 ANSI	Sterile Quantity: 96 tips/rack, 10 racks/pack, 5 packs/case	SPNF-30-CBK-R-S
 Conductive, Non-Filtered	250 µL	SPAN-8	 ANSI	Nonsterile Sterile Quantity: 96 tips/rack, 10 racks/pack, 5 packs/case	SPN-250-CBK-R SPN-250-CBK-R-S
 Conductive, Filtered	165 µL	SPAN-8	 ANSI	Sterile Quantity: 96 tips/rack, 10 racks/pack, 5 packs/case	SPNF-180-CBK-R-S



Format: 96 tip (1 mL size are 72 tips/rack)
 Tip Volume Range Selection: 20 µL - 1000 µL
 Material: Clear Polypropylene
 Certified RNase-/DNase-free, nonpyrogenic
 Available Options:

- ▶ With or without aerosol-resistant filters
- ▶ Nonsterile or sterilized
- ▶ Standard or MAXIMUM RECOVERY®

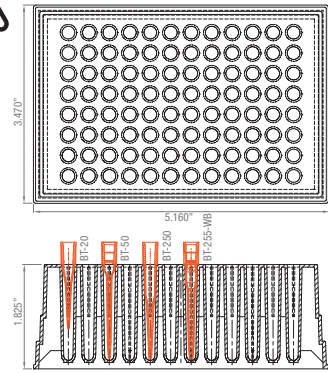

Tip Box Format: Non-ANSI
 Material: Number 5 Polypropylene

Axygen® Robotic Tips

Type	Max Volume	Compatible Head	Tip Box	Packaging	Standard Cat. No.	MAXIMUM RECOVERY® Cat. No.
	100 µL	P20, MP20, P200, MP200		Nonsterile Sterile <i>Quantity: 96 tips/rack, 10 racks/pack, 5 packs/case</i>	BT-20-R BT-20-R-S	BT-20-L-R BT-20-L-R-S
	20 µL	P20, MP20, P200, MP200		Sterile <i>Quantity: 96 tips/rack, 10 racks/pack, 5 packs/case</i>	BTF-20-R-S	BTF-20-L-R-S
	50 µL	P20, MP20, P200, MP200		Nonsterile Sterile <i>Quantity: 96 tips/rack, 10 racks/pack, 5 packs/case</i>	BT-50-R BT-50-R-S	BT-50-L-R BT-50-L-R-S
	30 µL	P20, MP20, P200, MP200		Sterile <i>Quantity: 96 tips/rack, 10 racks/pack, 5 packs/case</i>	BTF-50-R-S	BTF-50-L-R-S
	250 µL	P200, MP200		Nonsterile Sterile <i>Quantity: 96 tips/rack, 10 racks/pack, 5 packs/case</i>	BT-250-R BT-250-R-S	BT-250-L-R BT-250-L-R-S
	165 µL	P200, MP200		Sterile <i>Quantity: 96 tips/rack, 10 racks/pack, 5 packs/case</i>	BTF-180-R-S	BTF-180-L-R-S
	250 µL	P200, MP200		Nonsterile Sterile <i>Quantity: 96 tips/rack, 10 racks/pack, 5 packs/case</i>	BT-255-WB-R BT-255-WB-R-S	
	165 µL	P200, MP200		Sterile <i>Quantity: 96 tips/rack, 10 racks/pack, 5 packs/case</i>	BTF-165-WB-R-S	
	1000 µL	P1000		Nonsterile <i>Quantity: 72 tips/rack, 5 racks/case</i>	BT-1000-R	
	1000 µL	P1000		Sterile <i>Quantity: 72 tips/rack, 5 racks/case</i>	BTF-1000-R-S	

Format: 96 tip
 Tip Volume Range Selection: 180 µL - 200 µL
 Material: Clear Polypropylene
 Certified RNase-/DNase-free, nonpyrogenic
 Available Options:
 ▶ With or without aerosol-resistant filters
 ▶ Nonsterile or sterilized

Tip Box Format: Non-ANSI
 Material: Number 5 Polypropylene

Axygen® Robotic Tips

Type	Max Volume	Compatible Head	Tip Box	Packaging	Standard Cat. No.
Non-Filtered, 	200 µL	CCS P50		Nonsterile Sterile <i>Quantity: 96 tips/rack, 10 racks/pack, 5 packs/case</i>	MT-200-R MT-200-R-S
Filtered 	180 µL	CCS P200		Sterile <i>Quantity: 96 tips/rack, 10 racks/pack, 5 packs/case</i>	MTF-200-R-S

Single-well Reservoirs



Volume	Color	Product Description	Axygen Cat. No.
92 mL	Clear	Reservoir, single-well, 384 bottom troughs, low profile <i>Quantity: 25 reservoirs/case</i>	RES-SW384-LP
170 mL	Clear	Reservoir, single-well, 384 bottom troughs, mid profile Optimized for use with P30 tips <i>Quantity: 25 reservoirs/case</i>	RES-SW384-FX
282 mL	Clear	Reservoir, single-well, 384 bottom troughs, high profile <i>Quantity: 25 reservoirs/case</i>	RES-SW384-HP
	Clear	Baffle for reservoirs, set of 4 divider inserts; creates 9 separate chambers with flow-through arches <i>Quantity: 10 sets/case</i>	RES-BAFFLE

Multi-well Reservoirs



Max. Vol.	Max. Well Vol.	Color	Product Description	Axygen Cat. No.
32 mL	4.0 mL	Clear	Reservoir, multi-well, 8-channel, low profile <i>Quantity: 25 reservoirs/case</i>	RES-MW8-LP
21 mL	1.75 mL	Clear	Reservoir, multi-well, 12-channel, low profile <i>Quantity: 25 reservoirs/case</i>	RES-MW12-LP
80 mL	10 mL	Clear	Reservoir, multi-well, 8-channel, high profile <i>Quantity: 25 reservoirs/case</i>	RES-MW8-HP
84 mL	7.0 mL	Clear	Reservoir, multi-well, 12-channel, high profile <i>Quantity: 25 reservoirs/case</i>	RES-MW12-HP

HTS Transwell®-96 Well Permeable Support Systems and Plates

- ▶ The HTS Transwell-96 Well Permeable Support has an array of 96 wells with membrane inserts connected by a rigid, robotics-friendly tray that enables all 96 inserts to be handled as a single unit
- ▶ Choice of either polyester (PET) membrane (1.0 µm, 8.0 µm pore sizes) or polycarbonate (PC) membrane (0.4 µm, 3.0 µm, 5.0 µm pore sizes)
- ▶ 0.143 cm² membrane area per well, providing 20% to 50% more surface area for cell growth than other commercially available systems
- ▶ Large apical and basolateral access ports allow efficient media sampling and facilitate automated or manual access
- ▶ Optimized for automation, with multichannel feeder ports, improved gripping surface, and standard bar codes
- ▶ The reservoir plate allows for simultaneous feeding of 96 wells and comes with a removable media stabilizer to reduce the risk of spills during handling
- ▶ The receiver plate isolates each well to enable 96 individual assays
- ▶ Sterilized by gamma radiation
- ▶ The HTS Transwell-96 Systems (0.4 µm PC and 1.0 µm PET) are packaged with the 96 well insert plate in a reservoir plate and includes the 96 well receiver plate with lid.
- ▶ The HTS Transwell-96 Well Plates (3.0 and 5.0 µm PC, 8.0 µm PET) are packaged with the 96 well insert plate in the 96 well receiver plate with lid. Reservoir plates may be purchased separately.

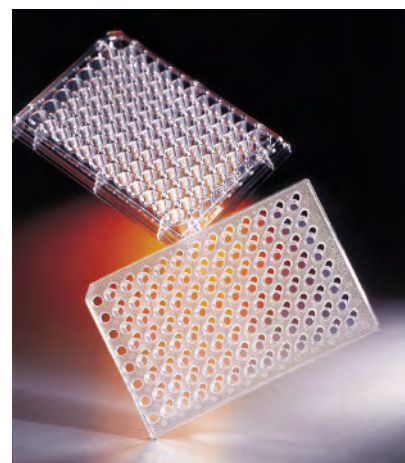

Corning Cat. No.	Description	Membrane Pore Size (µm)	Membrane	Qty/Pk	Plates/Cs
3381	HTS Transwell-96 System, reservoir and receiver plates with 2 lids	0.4	PC	1	1
3391	HTS Transwell-96 System, reservoir and receiver plates with 2 lids	0.4	PC	1	5
3380	HTS Transwell-96 System, reservoir and receiver plates with 2 lids	1	PET	1	1
3392	HTS Transwell-96 System, reservoir and receiver plates with 2 lids	1	PET	1	5
3385	HTS-Transwell-96 well plate, receiver plate and lid, individual	3	PC	1	2
3386	HTS-Transwell-96 well plate, receiver plate and lid, bulk	3	PC	4	8
3387	HTS-Transwell-96 well plate, receiver plate and lid, bulk	5	PC	4	8
3388	HTS-Transwell-96 well plate, receiver plate and lid, individual	5	PC	1	2
3374	HTS-Transwell-96 well plate, receiver plate and lid, individual	8	PET	1	2
3384	HTS-Transwell-96 well plate, receiver plate and lid, bulk	8	PET	4	8
3382	HTS Transwell-96 receiver plate with lid, tissue culture treated	n/a	n/a	10	10
3383	HTS Transwell-96 reservoir plate with removable media stabilizer and lid, not treated	n/a	n/a	10	10
3583	HTS Transwell-96 black receiver plate with lid, tissue culture treated	n/a	n/a	10	10

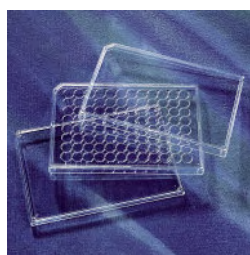

Lids

Cat. No.	Description	Sterile	Qty/Pk	Qty/Cs
3085	DMSO-resistant Cyclic olefin lid, tinted amber, without corner notch	No	25	50
3098	Universal lid without corner notch	Yes	25	100
3099	Universal lid with corner notch	Yes	25	50
3931	Low evaporation lid with condensation rings	No	25	50
3935	Black universal lid with corner notch	Yes	25	50

Format: 96 tip and 384 tip
 Tip Volume Range Selection: 20 µL - 200 µL
 Material: Clear Polypropylene
 Certified RNase-/DNase-free, nonpyrogenic
 Available Options:

- ▶ With or without aerosol-resistant filters
- ▶ Nonsterile or sterilized
- ▶ Standard or MAXIMUM RECOVERY®

Tip Box Format: ANSI
 Material: Number 5 Polypropylene

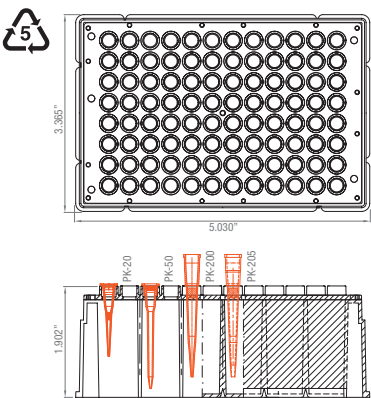

Axygen® Robotic Tips











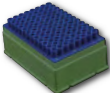

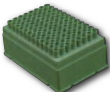

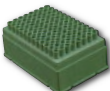

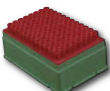
Type	Max Volume	Compatible Head	Tip Box	Packaging	Standard Cat. No.	MAXIMUM RECOVERY Cat. No.
 Non-Filtered	20 µL	MDT-96 P50	 ANSI	Nonsterile Sterile Quantity: 96 tips/rack, 10 racks/pack, 5 packs/case	PK-20-R PK-20-R-S	PK-20-L-R PK-20-L-R-S
 Filtered	20 µL	MDT-96 P50	 ANSI	Sterile Quantity: 96 tips/rack, 10 racks/pack, 5 packs/case	PKF-20-R-S	PKF-20-L-R-S
 Non-Filtered	50 µL	MDT-96 P50	 ANSI	Nonsterile Sterile Quantity: 96 tips/rack, 10 racks/pack, 5 packs/case	PK-50-R PK-50-R-S	PK-50-L-R PK-50-L-R-S
 Filtered	30 µL	MDT-96 P50	 ANSI	Sterile Quantity: 96 tips/rack, 10 racks/pack, 5 packs/case	PKF-30-R-S	PKF-30-L-R-S
 Non-Filtered	235 µL	MDT-96 P235	 ANSI	Nonsterile Sterile Quantity: 96 tips/rack, 10 racks/pack, 5 packs/case	PK-200-R PK-200-R-S	PK-200-L-R PK-200-L-R-S
 Filtered	180 µL	MDT-96 P235	 ANSI	Sterile Quantity: 96 tips/rack, 10 racks/pack, 5 packs/case	PKF-180-R-S	PKF-180-L-R-S
 Wide-bore, Non-Filtered	235 µL	MDT-96 P235	 ANSI	Nonsterile Sterile Quantity: 96 tips/rack, 10 racks/pack, 5 packs/case	PK-205-WB-R PK-205-WB-R-S	
 Wide-bore, Filtered	180 µL	MDT-96 P235	 ANSI	Sterile Quantity: 96 tips/rack, 10 racks/pack, 5 packs/case	PKF-205-WB-R-S	
 Non-Filtered	30 µL	MDT 384-30 µL	 ANSI	Nonsterile Sterile Quantity: 384 tips/rack, 10 racks/pack, 5 packs/case	PK-384-R PK-384-R-S	
 Filtered	30 µL	MDT 384-30 µL	 ANSI	Sterile Quantity: 384 tips/rack, 10 racks/pack, 5 packs/case	PKF-384-R-S	

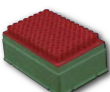
Format: 96 tip
 Tip Volume Range Selection: 20 µL - 1000 µL
 Material: Conductive LLS Black Polypropylene
 Certified RNase-/DNase-free, nonpyrogenic
 Available Options:
 ▶ With or without aerosol-resistant filters
 ▶ Nonsterile or sterilized

Tip Box Format: ANSI
 Material: Number 5 Polypropylene

1 mL Tip Box Format: Non-ANSI hanging tip rack
 Material: Number 7 Polycarbonate

Axygen® Robotic Tips

Type	Max Volume	Compatible Head	Tip Box	Packaging	Standard Cat. No.
	20 µL	Variospan-1, 4, 8	 	Nonsterile Sterile Quantity: 96 tips/rack, 10 racks/pack, 5 packs/case	RRP-20-CBK-R RRP-20-CBK-R-S
	50 µL	Variospan-1, 4, 8	 	Nonsterile Sterile Quantity: 96 tips/rack, 10 racks/pack, 5 packs/case	RRP-50-CBK-R RRP-50-CBK-R-S
	25 µL	Variospan-1, 4, 8	 	Sterile Quantity: 96 tips/rack, 10 racks/pack, 5 packs/case	RRF-25-CBK-R-S
	235 µL	Variospan-1, 4, 8	 	Nonsterile Sterile Quantity: 96 tips/rack, 10 racks/pack, 5 packs/case	RRP-200-CBK-R RRP-200-CBK-R-S
	175 µL	Variospan-1, 4, 8	 	Sterile Quantity: 96 tips/rack, 10 racks/pack, 5 packs/case	RRF-175-CBK-R-S
	1000 µL	Variospan-1, 4, 8	 	Nonsterile Sterile Quantity: 96 tips/rack, 16 racks/case	TT-1000-CBK-HTR TT-1000-CBK-HTR-S
	1000 µL	Variospan-1, 4, 8	 	Sterile Quantity: 96 tips/rack, 16 racks/case	TTF-1000-CBK-HTR-S

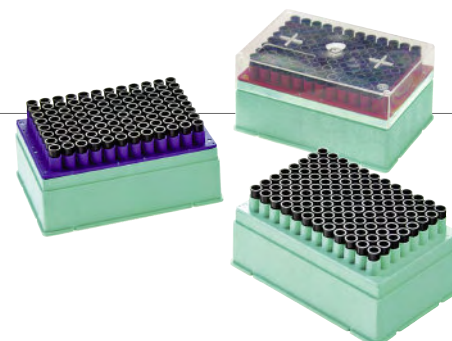

Format: 96 tip
 Tip Volume Range Selection: 20 µL - 1000 µL
 Material: Clear Polypropylene
 Certified RNase-/DNase-free, nonpyrogenic
 Available Options:
 ▶ With or without aerosol-resistant filters
 ▶ Nonsterile or sterilized

Tip Box Format: ANSI
 Material: Number 5 Polypropylene

1 mL Tip Box Format: Non-ANSI hanging tip rack
 Material: Number 7 Polycarbonate

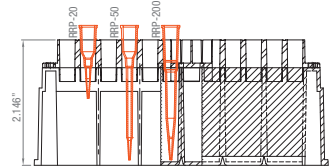
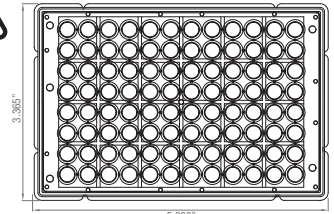

Axygen® Robotic Tips





Type	Max Volume	Compatible Head	Tip Box	Packaging	Standard Cat. No.
Non-Filtered	20 µL	Variospan-1, 4, 8	ANSI	Nonsterile Sterile Quantity: 96 tips/rack, 10 racks/pack, 5 packs/case	RRP-20-C-R RRP-20-C-R-S
Non-Filtered	50 µL	Variospan-1, 4, 8	ANSI	Nonsterile Sterile Quantity: 96 tips/rack, 10 racks/pack, 5 packs/case	RRP-50-C-R RRP-50-C-R-S
Filtered	25 µL	Variospan-1, 4, 8	ANSI	Sterile Quantity: 96 tips/rack, 10 racks/pack, 5 packs/case	RRF-25-C-R-S
Non-Filtered	235 µL	Variospan-1, 4, 8, P235	ANSI	Nonsterile Sterile Quantity: 96 tips/rack, 10 racks/pack, 5 packs/case	RRP-200-C-R RRP-200-C-R-S
Filtered	175 µL	Variospan-1, 4, 8, P235	ANSI	Sterile Quantity: 96 tips/rack, 10 racks/pack, 5 packs/case	RRF-175-C-R-S
Non-Filtered	1000 µL	Variospan-1, 4, 8	HANGING TIP RACKS	Nonsterile Sterile Quantity: 96 tips/rack, 16 racks/case	TT-1000-C-HTR TT-1000-C-HTR-S
Filtered	1000 µL	Variospan-1, 4, 8	HANGING TIP RACKS	Sterile Quantity: 96 tips/rack, 16 racks/case	TTF-1000-C-HTR-S

Format: 96 tip
 Tip Volume Range Selection: 250 µL - 1100 µL
 Material: Clear Polypropylene
 Certified RNase-/DNase-free, nonpyrogenic
 Available Options:
 ▶ With or without aerosol-resistant filters
 ▶ Nonsterile or sterilized

Tip Box Format: Non-ANSI hanging tip rack
 Material: Number 7 Polycarbonate

Axygen® Robotic Tips

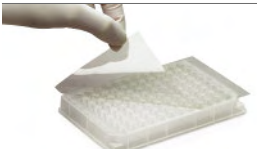
Type	Max Volume	Compatible Head	Tip Box	Packaging	Standard Cat. No.
Non-Filtered	300 µL	BioRobot		Nonsterile Sterile <i>Quantity: 96 tips/rack, 24 racks/case</i>	QT-300-R QT-300-R-S
Filtered	250 µL	BioRobot		Sterile <i>Quantity: 96 tips/rack, 24 racks/case</i>	QTF-300-R-S
Conductive, Non-Filtered	300 µL	BioRobot		Nonsterile Sterile <i>Quantity: 96 tips/rack, 24 racks/case</i>	QT-300-CBK-R QT-300-CBK-R-S
Conductive, Filtered	250 µL	BioRobot		Sterile <i>Quantity: 96 tips/rack, 24 racks/case</i>	QTF-300-CBK-R-S
Non-Filtered	1100 µL	BioRobot		Nonsterile Sterile <i>Quantity: 96 tips/rack, 16 racks/case</i>	QT-1100-R QT-1100-R-S
Filtered	1000 µL	BioRobot		Sterile <i>Quantity: 96 tips/rack, 16 racks/case</i>	QTF-1100-R-S
Conductive, Non-Filtered	1100 µL	BioRobot		Nonsterile Sterile <i>Quantity: 96 tips/rack, 16 racks/case</i>	QT-1100-CBK-R QT-1100-CBK-R-S
Conductive, Filtered	1000 µL	BioRobot		Sterile <i>Quantity: 96 tips/rack, 16 racks/case</i>	QTF-1100-CBK-R-S

	Axygen Cat. No.	Description	Qty/Pk	Qty/Cs
	Breathable			
	BF-400	Breathable sealing film for tissue culture plates, deep well plates, 96 well plates for cell growth	100	10
	BF-400-S	Presterilized breathable sealing film for tissue culture plates deep well plates, 96 well plates for cell growth, 25 pieces per bag, 2 bags	50	10
	Aluminum			
	PCR-AS-200	Aluminum sealing film for thermal sealing and general sealing purposes	100	5
	PCR-AS-600	PCR aluminium sealing film for thermal sealing and general sealing purposes	100	5
	AxySeal			
	PCR-SP	AxySeal sealing film for PCR microplates. Designed for ELISA/EIA applications	100	5
	PCR-SP-S	AxySeal presterilized sealing film for PCR microplates Designed for ELISA/EIA applications	100	5
	CyclerSeal			
	PCR-TS	CyclerSeal sealing film for PCR microplates. Designed for ELISA/EIA applications.	100	5
	PCR-TS-900	CyclerSeal sealing film for PCR microplates, suitable for water-baths, 6 mil	50	5
	UltraClear			
	UC-500	Ultraclear pressure sensitive sealing film	100	5

PlateMax Semi-Automatic Plate Sealer ▶ new

Heat sealing is arguably the most effective method for sealing assay plates, storage plates and PCR plates. Axygen's tabletop PlateMax offers an easy to use system for sealing individual plates and seals in a compact design. The intuitive control system allows accurate setting of sealing temperature and sealing time for optimal results. A large LCD display shows all settings and operating conditions.

- ▶ Fully variable temperature and seal time for all types of plates and sealing films
- ▶ Designed to seal polypropylene and polystyrene plates
- ▶ Plate holder and adapters allow use of virtually any ANSI microplate or PCR plate
- ▶ Unique Seal Frame system holds films in position and flat during sealing
- ▶ Motorized drawer and motorized sealing platen guarantee consistent results



Axygen Cat. No.	Description
HS-1120	PlateMax Semi-Automatic Heat Sealer, includes adapters for standard and deep well microplates, 120V
HS-1230	PlateMax Semi-Automatic Heat Sealer, includes adapters for standard and deep well microplates, 230V
HS-PCR-ADAPTER	PlateMax adapter for sealing assay and PCR plates
HS-FLT-ADAPTER	PlateMax support block for assay and storage plates

Heat Sealing Films for use with the PlateMax Plate Sealer

Axygen Cat. No.	Description	Qty/Unit	Unit/Cs
MF-111	Easy pierce heat sealing film	100	10
MF-300	Heat sealing film with paper backing for general storage and PCR applications	100	

	Axygen Cat. No.	Description	Qty/Pk
	RES-SW8-HP	AxyVoir, high profile single well, 8 bottom reservoir	25
	RES-SW12-HP	AxyVoir, high profile single well, 12 bottom reservoir	25
	RES-SW96-HP	AxyVoir, high profile single well, 96 bottom reservoir	25
	RES-SW1-LP	AxyVoir, low profile single well, 1 bottom reservoir	25
	RES-SW96-LP	AxyVoir, low profile single well, 96 bottom reservoir	25

Platemax®

Heat Seal Roll Films for Automated Microplate Sealing Instruments



Axygen Cat#	Sealing Film Roll Type	Size	Compatibility
<i>Real-Time:</i>			
HSF-UCR-L	Sealing Film Roll, qPCR, pierceable, removable; 1 roll per case	115 mm x 500M	Agilent
HSF-UCR-P	Sealing Film Roll, qPCR, pierceable, removable; 1 roll per case	78 mm x 500M	ALPS
HSF-UCP-L	Sealing Film Roll, qPCR, permanent; 1 roll per case	115 mm x 500M	Agilent
HSF-UCP-P	Sealing Film Roll, qPCR, permanent; 1 roll per case	78 mm x 610M	ALPS
<i>Pierceable:</i>			
HSF-AS-300-L	Sealing Film Roll, Aluminum, pierceable; 1 roll per case	115 mm x 500M	Agilent
HSF-AS-300-P	Sealing Film Roll, Aluminum, pierceable; 1 roll per case	78 mm x 610M	ALPS
<i>Easy Peel:</i>			
HSF-TS-L	Sealing Film Roll, CycloSeal, easy peel; 1 roll per case	115 mm x 500M	Agilent
HSF-TS-P	Sealing Film Roll, CycloSeal, easy peel; 1 roll per case	78 mm x 610M	ALPS

	Axygen Cat. No.	Description	Qty/Pk	Pk/Cs
	P-2ML-SQ-C <i>Compatible with:</i>	2.0 mL deep well square plate AM-2ML-SQ-C AM-2ML-SQ-IMP	5	5
	P-384-120SQ-C <i>Compatible with:</i>	120 µL 384 deep well "Diamond Plate" microplate with square wells AM-384-DW-SQ AM-384-SQ-IMP	5	10
	P-384-240SQ-C <i>Compatible with:</i>	240 µL 384 deep well "Diamond Plate" with square wells AM-384-DW-SQ AM-384-SQ-IMP	5	10
	P-5ML-48-C <i>Compatible with:</i>	5 mL, 48 rectangular well deep well plate with pyramid bottom AM-48-IMP	5	5
	P-DW-10ML-24-C	10 mL, 24 well deep well plate with rectangular wells	5	5
	P-DW-11-C <i>Compatible with:</i>	1.1 mL, 96 well deep well plate AM-2ML-RD AM-2ML-RD-IMP	5	10
	P-DW-20-C <i>Compatible with:</i>	2.0 mL, 96 well deep well plate AM-2ML-RD AM-2ML-RD-IMP	5	10
	P-DW-500-C <i>Compatible with:</i>	600 µL, 96 well deep well plate (ANSI footprint) (AL) AM-500UL-RD	5	10

























new and improved notches



AxyMats are patented sealing mats designed for high throughput screening and storage applications. Made of research-grade silicone, they can be autoclaved and following a bleach wash and ethanol rinse protocol, they can also be reused. AxyMats are pierceable and self-sealing, ideal for automated processes and can be used in sub-zero environments.



Chemically Resistant **ImpermaMats** (patent pending) are a chemical-resistant line of sealing mats. They are made for use in assays involving strong solvents such as DMSO and similarly harsh solvents. Specifically designed for Axygen deep well and microplates, they contain no extractables to contaminate samples. They feature a tight seal to the plate - no sample evaporation or well-to-well contamination. Usable within wide temperature range – from -80°C up to +121°C. Cost effective – can be reused.

	Axygen Cat. No.	Description	Qty/Pk	Qty/Cs
 	AM-2ML-RD <i>Compatible with:</i>	Sealing mat for 2 mL 96 well deep well plates with round holes P-DW-11-C P-DW-20-C P-96-450R-C P-96-450V-C    	10	5
 	AM-2ML-RD-IMP <i>Compatible with:</i>	ImpermaMat, chemical resistant silicone sealing mat for 2 mL 96 round deep well plates P-DW-11-C P-DW-20-C P-96-450R-C P-96-450V-C    	10	5
 	AM-2ML-SQ <i>Compatible with:</i>	Sealing mat for 2 mL 96 well deep well plates with square holes P-2ML-SQ-C 	10	5
 	AM-2ML-SQ-IMP <i>Compatible with:</i>	ImpermaMat, chemical resistant silicone sealing mat for 2 mL 96 square deep well plates P-2ML-SQ-C 	10	5
 	AM-384-DW-SQ <i>Compatible with:</i>	Sealing mat for 384 well deep well plates P-384-120SQ-C P-384-240SQ-C  	10	5
 	AM-384-SQ-IMP <i>Compatible with:</i>	ImpermaMat, chemical resistant silicone sealing mat for 384 deep well plates P-384-120SQ-C P-384-240SQ-C  	10	5
 	AM-48-IMP <i>Compatible with:</i>	ImpermaMat, chemical resistant silicone sealing mat for 5 mL 48 rectangular well deep well plates P-5ML-48-C 	10	5
 	AM-500UL-RD <i>Compatible with:</i>	Silicone sealing mat for 500 μ L 96 well v-bottom deep well plates P-DW-500-C 	10	5
 	AM-750UL-RD <i>Compatible with:</i>	Sealing mat for 750 μ L 96 well deep well plates Optimized to fit 1.0 mL Corning deep well plates and the Axygen MTS System.	10	5



Corning's Label-free Epic System

Corning Incorporated combined its expertise in materials science, optics, and life sciences to create the label-free Corning Epic System. This drug discovery platform consists of an optical reader and an ANSI-standard 384 well microplate with optical biosensors and attachment chemistry inside each well. The Epic System fully integrates with laboratory automation to perform high-throughput biochemical and cell-based screening.

Key Features of the Label-free Corning Epic System

- ▶ High sensitivity: fragment screening and primary cells
- ▶ High throughput: 384 well format
- ▶ Robust assay performance
- ▶ More physiologically relevant data
- ▶ No fluorescent or radioactive labels
- ▶ Variety of microplate surface chemistries available

Epic System Integration

The Epic System fully integrates with ANSI-standard robotics. An optional Epic Liquid Handling Accessory (LHA) is available.



Optional Epic Liquid Handling Accessory



Corning Epic System Microplates

Cat. No.	Description	Qty/Pk	Qty/Cs
384 Well Microplates			
5040	Cell Assay	1	10
5041	Biochemical Assay	1	10
5042	Fibronectin-Coated Cell Assay	1	10
5046	Biochem Assay, User Activated	1	10
5047	Streptavidin Coated Assay	1	10

Corning Epic Label-free Technology is also available through Corning Epic Service for assay development, screening and pathway confirmation.

Optical Label-free Biosensors for Biochemical and Cell-Based Assays

Perform label-free, high-throughput assays via the Corning Epic System

The Epic System couples proven label-free technology with the benefits of high-throughput screening. Our label-free technology uses optical biosensors to study biochemical interactions and cellular changes. With sensitivity capable of detecting primary cell responses and fragment interactions and throughputs up to 100,000 compounds a day, Epic can take on your toughest targets.

Operating Principle

Resonant waveguide optical biosensors measure changes in light's index of refraction, thereby becoming highly sensitive instruments for detecting mass changes within approximately 200 nm of the sensor's surface. The biosensor is comprised of a glass substrate with a periodic grating that is formed on top of the glass. A dielectric waveguide coating on top of the grating completes the biosensor and enables light propagation through the sensor. When the biosensor is illuminated with broadband light, it reflects a specific wavelength of light that is a sensitive function of the index of refraction to the sensor surface. Mass changes within the detection zone caused by mass redistribution of cellular components upon activation can be detected by monitoring changes in light's index of refraction off the biosensor. To enable high-throughput label-free screening, optical biosensors are integrated into each well of an industry standard 384 well microplate.

Label-free Optical Biosensor Applications

Biochemical

- ▶ Aggregation assays ▶ new
- ▶ Antibody screening
- ▶ Epitope mapping
- ▶ Fragment-based screening
- ▶ Functional protease
- ▶ Hit-to-lead protein-small molecule binding
- ▶ Kinases
- ▶ Protein-protein interactions
- ▶ Protein-small molecule

Cell-Based

- ▶ Cell-based biomarkers
- ▶ Chemotaxis
- ▶ GPCRs (Gi, Gs, Gq)
- ▶ Ion channels
- ▶ Pharmacological profiling
- ▶ Receptor panning
- ▶ Stem cells
- ▶ Viral detection

Biochemical and Cell-Based Assays

For biochemical analysis, optical biosensors detect the direct binding of biomolecular interactions. To study protein/protein interactions, the target protein is immobilized to the sensor surface via amine coupling. After thermal equilibrium is reached, a broadband light takes a baseline read. Then the second protein is added followed by a wash step. A final optical scan will reveal a wavelength shift if the proteins are bound together. This approach enables high-throughput label-free drug discovery for fragment-based screening, small molecular drug discovery, antibodies and more.

For cell-based assays, optical biosensors measure the aggregate movement of the many intracellular proteins and biomolecules in response to drug compounds. In a typical assay, cells are first seeded onto the microplate sensor surface and cultured to confluency. After compound addition, the direct, real-time redistribution of cellular mass is monitored via optical scanning. Unlike conventional label-based cell-based assays, which are generally limited to detecting one molecular species, optical biosensors detect the aggregate cellular mass redistribution within the detection zone, capturing more information to investigate a compound's pharmacological properties. Optical label-free assays may use engineered cells or more biologically relevant cells like human primary cells and stem cells. Moreover, because this assay is pathway unbiased, it is amenable to a wide range of therapeutic targets.

Epic Detection Principle for Cell-Based Assays

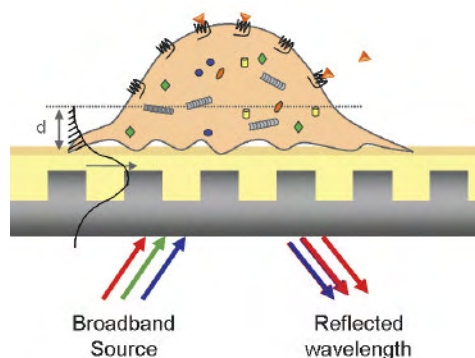

PerkinElmer® EnSpire® Multimode Plate Reader with Corning Label-free Technology

Corning Epic Technology is now also available in a bench-top instrument.

Corning and PerkinElmer have developed the first multimode plate reader to offer both labeled and optical label-free detection technology on a single platform.

The EnSpire Multimode Plate Reader from PerkinElmer is a high performance, compact and configurable instrument designed with filter or quad-monochromator capabilities.

For further information visit www.perkinelmer.com.

Assay Microplates

Chemiluminescent HRP-Based Assay Using Corning White Microplates

A comparison of the performance of white microplates from several microplate manufacturers to that of Corning 96 well white microplate using a model HRP-based luminescent assay system.

Corning Non-Binding Surface Treatment to Reduce Non-Specific Binding To Microplates

This 2-page technical note evaluates Corning NBS microplates for Scintillation Proximity Assays.

Corning 384 Well Low Volume Microplate Performance in Miniaturized Assays (ALSP-AN-014)

This technical note describes the performance of low volume microplates using a homogeneous fluorescence polarization assay at low volumes.

Fluorescent Polarization Kinase Assay Miniaturization in Corning 96 Well Half Area and 384 Well Microplates

This 4-page technical note examines assay miniaturization in Corning 96 well, 96 well half area, and 384 well microplates using fluorescence polarization tyrosine kinase assays.

Comparative Analysis of Corning Microplates using the PerkinElmer® EnVision® Multilabel Microplate Reader SnAPPShot (CLS-AN-131)

The following compares and contrasts various 96 and 384 well microplate formats in fluorescent and luminescent biochemical assays using the PerkinElmer EnVision multilabel microplate reader.

Impact of Microplate Choice on HTRF® Assay Performance SnAPPShot (CLS-AN-096)

This SnAPPShot compares and contrasts the importance of microplate color and geometry in determining HTRF assay performance.

Corning NBS 384 Well Low Volume Microplates Perform Well in Fluorescence Polarization Based Assays SnAPPShot (CLS-AN-056)

This brief 2-page technical report shows that NBS microplates do not interfere with the binding affinity of neurotensin receptors and perform well in FP based receptor-ligand binding assays.

Performance Advantage of Corning NBS Microplates in Homogeneous Biochemical Assays SnAPPShot (CLS-AN-055)

This brief 2-page technical report shows that NBS microplates provide the widest signal dynamic range and most stable fluorescence signals for this HTS assay versus not treated microplates.

Bar Code Basics Technical Bulletin (CLS-AN-021)

This 3-page bulletin is a reference tool for customers that provides the anatomy of a bar code and terminology pertaining to the bar code structure.

Cell Culture Microplates

Helpful Hints to Manage Edge Effects of Cultured Cells for High-Throughput Screening (CLS-AN-038W)

This technical note is a compendium of techniques, collected from Corning Cell Culture facilities and customers, to reduce the occurrence of irregular patterns of cell adhesion or "edge effect" in microplates.

Poly-D-Lysine Coated Microplates (ALSP-AN-015)

This 2-page application report describes binding and performance characteristics, and provides operating protocols for Corning's Poly-D-Lysine microplates.

Corning® CellBIND® Surface: An Improved Surface for Enhanced Cell Attachment Technical Report (CLS-AN-057)

The Corning CellBIND Surface is a patented plasma surface treatment for tissue culture vessels. This optimized tissue culture surface treatment increases the oxygen content of the polymer surface resulting in improved hydrophilicity and wettability, which is known to improve cell spreading and attachment.

Miniaturization of a Calcium Mobilization Assay in 384 Well Format SnAPPShot (CLS-AN-068)

In this study, we show a calcium mobilization assay that has been miniaturized to 25 to 40 µL using a new 384 well low volume (LV) black clear bottom (BCB) microplate from Corning. The results demonstrate that the quality of the data and assay performance on this LV microplate are comparable to that obtained from 384 well normal volume (NV) microplates.

Miniaturization of a Luciferase Reporter Gene Assay Show Enhanced Assay Performance With Considerable Cost Savings SnAPPShot (CLS-AN-093)

This short application note describes cost savings and cell-based assay improvement made possible by moving from a normal to a low volume 384 well format.

Considerations When Using Frozen Cells for High-Throughput Cell-Based Assays SnAPPShot (CLS-AN-117)

This SnAPPShot discusses the advantages and disadvantages of using batch-frozen versus continuously cultured cells in multiple assay formats.

Instrument and Microplate Considerations to Improve Image Capture and Data Generation During High Content Screens Application Note (CLS-AN-081)

Optimization of several parameters is essential during the development of a robust and informative high content screen, particularly when considering the complexity involved in cell-based assays. This 8-page report evaluates the impacts of instrument settings and microplate characteristics on assay robustness and data validity and provides a guide for significantly improving results when conducting a high content screen.

All literature is available in PDF file format at www.corning.com/lifesciences.

Warranty/Disclaimer: Unless otherwise specified, all products are for research use only. Not intended for use in diagnostic or therapeutic procedures. Not for use in humans. Corning Life Sciences makes no claims regarding the performance of these products for clinical or diagnostic applications.

For additional Axigen product or distributor information, please e-mail us at CLSCustServ@Corning.com, visit our website at www.corning.com/lifesciences/axigen or call 1.800.492.1110. Outside the United States, call 978.442.2200.

For Axigen technical information, please e-mail us at AxgSupport@Corning.com or call 1.800.429.9436. Outside the United States, call 510.494.8900.

Corning Incorporated
Life Sciences

836 North St.
Building 300, Suite 3401
Tewksbury, MA 01876
t 800.492.1110
t 978.442.2200
f 978.442.2476

www.corning.com/lifesciences

**Worldwide
Support Offices**

ASIA/PACIFIC

Australia/New Zealand
t 0402-794-347

China
t 86 21 2215 2888
f 86 21 6215 2988

India
t 91 124 4604000
f 91 124 4604099

Japan
t 81 3-3586 1996
f 81 3-3586 1291

Korea
t 82 2-796-9500
f 82 2-796-9300

Singapore
t 65 6733-6511
f 65 6861-2913

Taiwan
t 886 2-2716-0338
f 886 2-2516-7500

EUROPE

France
t 0800 916 882
f 0800 918 636

Germany
t 0800 101 1153
f 0800 101 2427

The Netherlands
t 31 20 655 79 28
f 31 20 659 76 73

United Kingdom
t 0800 376 8660
f 0800 279 1117

**All Other European
Countries**

t 31 (0) 20 659 60 51
f 31 (0) 20 659 76 73

**LATIN AMERICA
Brasil**

t (55-11) 3089-7419
f (55-11) 3167-0700

Mexico
t (52-81) 8158-8400
f (52-81) 8313-8589

CORNING | **FALCON** | **AXYGEN** | **GOSSELIN** | **PYREX**